



**VERCO DECKING, INC. a NUCOR Company**  
 4340 North 42nd Avenue  
 Phoenix, Arizona 85019  
 (602) 272-1347  
[www.vercodeck.com](http://www.vercodeck.com)

### STEEL DECK PANELS

**CSI DIVISION: 05 00 00 – METALS**  
**CSI SECTION: 05 31 00 – STEEL DECK**  
 05 31 13 – STEEL FLOOR DECKING  
 05 31 23 – STEEL ROOF DECKING

### 1.0 RECOGNITION

Steel deck panels recognized in this report have been evaluated for use as a component of horizontal or sloped floor and roof systems supporting out of plane loads, in-plane diaphragm shears, and in-plane axial loads. Physical characteristics and structural performance properties comply with the intent of the provisions of the following codes and regulations:

- 2018, 2015 and 2012 International Building Code® (IBC)
- 2018, 2015 and 2012 International Residential Code® (IRC)
- 2019 and 2016 California Building Code (CBC) – attached supplement
- 2020 City of Los Angeles Building Code (LABC) – attached supplement
- 2020 City of Los Angeles Residential Code (LARC) – attached supplement

### 2.0 LIMITATIONS

Use of the steel deck panels recognized in this report is subject to the following limitations:

**2.1 Sound Transmission Performance:** Acoustic performance is beyond the scope of this report.

**2.2 Fire-Resistance Ratings:** Fire-resistance performance is beyond the scope of this report.

**2.3** The steel deck panels shall be installed in accordance with the applicable code, the manufacturer’s published installation instructions, and this report. Where there is a conflict, the most restrictive requirements shall govern.

**2.4** Calculations and details demonstrating that the loads applied to the steel deck panels comply with this report shall be submitted to the building official for approval. Calculations and drawings shall be prepared, signed, and sealed by a registered design professional where required by the statutes of the jurisdiction in which the project is to be constructed.

**2.5** The steel panels recognized in this report are produced by Verco Decking, Inc. in Phoenix, Arizona; Fontana, California; and Antioch, California.

**2.6** The Sammys X-Press Anchors recognized in this report are produced in Elk Grove Village, Illinois.

### 3.0 PRODUCT USE

#### 3.1 General:

Steel deck panels may be designed to resist out-of-plane loads, in-plane diaphragm shear loads, and axial loads.

#### 3.2 Design:

**3.2.1 Out-of-Plane Strength and Deflection:** Out-of-plane strength of steel deck panels shall be determined using engineering mechanics and deck panel properties presented in this report. Steel deck panels shall not be used under conditions subject to loads that are predominately cyclic in nature unless a registered design professional submits substantiating calculations to the building official in accordance with AISI S100-16 Chapter M under the 2018 IBC and IRC (AISI S100-12 Chapter G under the 2012 and 2015 IBC and IRC).

Deflections resulting from out-of-plane loads shall comply with Section 1604.3 of the IBC.

**3.2.2 Composite Steel Deck-Slabs:** Composite steel deck-slab out-of-plane load strength (superimposed loads) shall be determined in accordance with ANSI/SDI C using properties and composite coefficients in this report. In accordance with ACI 318-14 26.4.1.4.1(c) or ACI 318-11 3.6.4, calcium chloride or admixtures containing chloride from sources other than impurities in admixture ingredients are prohibited from use in concrete cast against stay-in-place galvanized steel deck. Use of concrete-filled composite steel deck slabs to support loads that are predominantly vibratory is beyond the scope of this report.

**3.2.3 Reactions:** The strength of steel deck panels to resist reaction loads at supports and locations of concentrated loads shall be determined based on the either web crippling strength or web shear strength. Web crippling strength shall be determined in accordance with AISI S100-16 Section G5 under the 2018 IBC and IRC (AISI S100-12 Section C3.4 under the 2012 and 2015 IBC and IRC) and the properties in this report. Deck panel web shear strength of deck panel webs shall be determined in accordance with AISI S100-16 Section G2.1 under the 2018 IBC and IRC (AISI S100-12 Appendix 1 Section 1.2.2.2.1 under the 2012 and 2015 IBC and IRC) and the properties in this report. The strength of web-perforated deck panels shall be determined in accordance with the equations in this report.

*The product described in this Uniform Evaluation Service (UES) Report has been evaluated as an alternative material, design or method of construction in order to satisfy and comply with the intent of the provision of the code, as noted in this report, and for at least equivalence to that prescribed in the code in quality, strength, effectiveness, fire resistance, durability and safety, as applicable, in accordance with IBC Section 104.11. This document shall only be reproduced in its entirety.*





### 3.2.4 In-Plane (Diaphragm) Shear Strength and Stiffness:

The in-plane shear strength of steel roof deck, non-composite steel deck, or composite steel deck-slabs shall be determined in accordance with AISI S310-16 including the modifications and properties in this report. For steel deck-slabs, diaphragm shear strength and shear stiffness may be determined in accordance with the provisions of this report in lieu of AISI S310-16. The steel deck slab provisions in this report were developed based on full scale reverse cyclic testing.

When steel deck panels are used as the stressed skin shear carrying element of a horizontal or sloped diaphragm as defined in Section 1602 of the IBC, the diaphragm length and width shall be limited by one of the following: engineering mechanics, applied loads, shear capacity of the diaphragm, diaphragm shear deflection limited by the requirements of ASCE/SEI 7 in Sections 12.8.6 entitled, "Story Drift Determination", or Section 12.12 entitled, "Drift and Deformation". Shear deflection shall be based on the shear stiffness for the steel deck diaphragm and equations of mechanics.

The use of steel deck diaphragms for vertical diaphragms (shear walls) is beyond the scope of this report.

**3.2.5 Axial Strength:** The axial strength or combined axial and bending strength of steel deck panels shall be determined in accordance with AISI S100 using the properties in this report.

**3.2.6 Wall Bracing:** The design for anchorage of structural walls and transfer of anchorage forces into the diaphragm shall be in accordance with Section 12.11.2 of ASCE/SEI 7, subject to the following limitations:

1. Transfer of anchorage forces into diaphragm shall be in the direction parallel to the flutes (ribs) of the steel deck.
2. When acting as the continuous ties or struts between diaphragm chords, anchorage forces shall be distributed into the diaphragm in the direction parallel to the flutes (ribs) of the steel deck.
3. Combined axial load and bending shall be considered in accordance with Section H1 of AISI S100-16 under the 2018 IBC and IRC (Section H1 of AISI S100-12 under the 2015 and 2012 IBC and IRC) to determine the strength of steel deck (without concrete fill) used to resist wall anchorage forces or to resist continuous tie forces parallel to the flutes (ribs).
4. Power-actuated fasteners, self-drilling screws, or welded connections described in this report are permitted to provide positive means of attachment to satisfy the connection requirements in ASCE/SEI 7 Section 12.11.2.2.1.

### 3.2.7 Partial Panels, Openings, Holes or Penetrations through Steel Deck:

The registered design professional may submit design calculations and details to the building official for approval based on the principles of engineering mechanics for partial panels, openings, holes or penetrations. For lateral force resisting systems, the calculations shall consider the effects of partial panels, openings, holes, or penetrations on the overall strength and stiffness of the diaphragm.

**3.2.8 Supporting Member Materials:** Supporting members shall comply with the requirements of AISI S310-16.

**3.2.9 Bekaert Dramix® Steel Fiber:** Bekeart Dramix steel fibers shall comply with UES Evaluation Report ER-465 and the provisions of this report.

### 3.2.10 Connections:

**3.2.10.1 Self-Drilling Screws:** Self-drilling screws may be used to attach steel deck panels to supporting members and to attach the sidelaps of steel deck panels to each other in accordance with AISI S100 and AISI S310 unless described in this report. The screws shall be manufactured in accordance with SAE J78 and shall be compliant with ASTM C1513.

**3.2.10.2 Proprietary Fasteners:** Proprietary screws and power actuated fasteners (PAF's) may be used to attach steel deck panels to supporting members in accordance with this report. The fasteners shall be designed to attach steel deck panels to supporting members and shall be described in a current evaluation report issued by an approved and accredited evaluation service agency.

**3.2.10.3 Welds:** Welds may be used to attach steel deck panels to supporting members and to attach the sidelaps of steel deck panels to each other in accordance with AISI S100 and AISI S310-16. The minimum tensile strength of the weld filler shall be designated as a minimum of 60 ksi (413.7 MPa) and comply with the appropriate AWS standard.

**3.2.10.4 Non-Piercing Button Punch:** Non-piercing button punch may be used to attach the sidelaps of steel deck panels to each other in accordance with AISI S310-16.



**3.2.10.5 PunchLok® II System:** The PunchLok II system consists of PunchLok deck described in this report connected at sidelaps with the Vulcraft/Verco Group proprietary connection. Acoustical and cellular versions of the listed deck sections may also be used. The proprietary connection is referred to as the "Vulcraft/Verco Sidelap Connection 2" (VSC2), and is an interlocking connection between the male and female lips of the appropriate deck. A VSC2 connection is made in either direction relative to the female lip. A VSC2 connection is made when the sidelap material has been sheared and offset so the sheared surface of the steel deck panel male lip is visible. This punched portion measures 0.45 inch (11.4 mm) – 0.70 inch (17.8 mm) nominal width by 0.30 inch (7.6 mm) nominal height. The PunchLok II system shall be installed in accordance with Vulcraft/Verco Group instructions. The resulting VSC2 connection is illustrated on page 15 of this report.

**3.2.10.6 Shearflex Standoff Screws:** Shearflex Standoff Screws may be used as shear connectors between concrete-filled steel deck and steel support members in accordance with this report. Shearflex Standoff Screws shall be installed in accordance with UES Evaluation Report ER-366.

### 3.3 Installation:

Steel deck panel erection sequence and installation method is the responsibility of the contractor(s) performing installation of the steel deck panels. Installation shall be in accordance with this report, ANSI/SDI RD, ANSI/SDI NC and ANSI/SDI C and all welds shall comply with AWS D1.3. Where conflicts occur, the more restrictive shall govern. Additional installation information is available in the Steel Deck Institute (SDI MOC) Manual of Construction with Steel Deck and manufacturer's recommendations. Mechanical fasteners shall be installed in accordance with the manufacturer's current evaluation report issued by an approved and accredited evaluation service agency. Quality control during installation shall comply with ANSI/SDI QA/QC.

### 3.4 Inspections:

**3.4.1 General:** Special inspection is required in accordance with IBC Chapter 17. Quality control and quality assurance for deck installation shall comply with ANSI/SDI QA/QC, where the special inspector duties are as set forth for the quality assurance inspector (QAI).

**3.4.2 Jobsite Welding:** Periodic special inspection for welding shall be in accordance with IBC Section 1705.2.2. Prior to proceeding, the welder shall demonstrate the ability to produce the prescribed weld to the special inspector's satisfaction. The inspector's duties include verification of materials, weld preparation, welding procedures, and welding processes.

**3.4.3 Concrete:** Continuous and periodic special inspection for concrete and concrete reinforcement shall be in accordance with Section 1705.3 of the IBC. The inspector's duties include sampling and testing, and verification of concrete mixes, reinforcement types and placement, and concrete placement.

**3.4.4 Seismic-Force-Resisting Systems and Wind-Force-Resisting Systems:** Where the steel deck is used in a seismic-force-resisting system in structures assigned to Seismic Design Category C, D, E or F, periodic special inspections for weld, screw and power-actuated fastener connections are required in accordance with 2018 and 2015 IBC Section 1705.12.3 (2012 IBC Section 1705.11.3)

Where the steel deck is used in a wind-force-resisting system in structures located in areas described in 2018 and 2015 IBC Section 1705.11 (2012 IBC Section 1705.10), periodic special inspections for weld, screw and power-actuated fastener connections are required in accordance with 2018 and 2015 IBC Section 1705.11.3 (2012 IBC Section 1705.10.3).

## 4.0 PRODUCT DESCRIPTION

**4.1 Steel Deck Panels:** The steel deck panels described in this report are cold-formed from steel sheets into panels with fluted sections having galvanized, phosphatized/painted, painted/painted, or mill finishes. Panel characteristics including profile designation, sidelap type, applicable sidelap fasteners and perforation for fluted profiles are described in the tables and figures that accompany this report.

The galvanized deck panels are formed from either ASTM A653 or A1063 steel, with a minimum G30 galvanized coating designation. The phosphatized/painted, painted/painted, or mill finished steel deck panels are formed from either ASTM A1008 or A1039 steel. Phosphatized/painted deck panels have a phosphatized (uncoated) top surface and primer painted bottom surface.

Painted/painted deck panels have primer painted top and bottom surfaces. Mill-finished deck panels have no coating on either top or bottom surfaces.

Verco® and PunchLok® are registered trademarks of Nucor Corporation or its affiliates.

**4.2 Concrete:** Concrete shall be either lightweight concrete or normal weight concrete and comply with Chapter 19 of the IBC. In accordance with ACI 318-14 26.4.1.4.1(c) or ACI 318-11 3.6.4, calcium chloride or admixtures containing chloride from sources other than impurities in admixture ingredients are prohibited from use in concrete cast against stay-in-place galvanized steel deck or embedded items. The minimum compressive strength shall be as indicated in the tables and figures of this report.



## 5.0 IDENTIFICATION

Each bundle of deck panels is identified with a visible label. The label includes the manufacturer's name (Verco Decking, Inc.), production location (Phoenix, Arizona; Fontana, California; Antioch, California), deck type, steel gage, one of the IAPMO ES Marks of Conformity noted below, and evaluation report number (ER-2018).

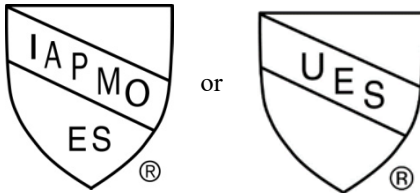

IAPMO UES ER-2018

## 6.0 SUBSTANTIATING DATA

Data in accordance with the IAPMO Uniform Evaluation Service Evaluation Criteria EC007-2020, Evaluation Criteria for Steel Composite, Non-composite, and Roof Deck Construction. Test reports are from laboratories in compliance with ISO/IEC 17025.

## 7.0 STATEMENT OF RECOGNITION

This evaluation report describes the results of research completed by IAPMO Uniform Evaluation Service on Vulcraft/Verco Group Steel Floor Decking and Steel Roof Decking. Products are manufactured at locations noted in Section 2.5 and 2.6 of this report under a quality control program with periodic inspection under the supervision of IAPMO UES.

**Brian Gerber, P.E., S.E.**  
Vice President, Technical Operations  
Uniform Evaluation Service

**Richard Beck, PE, CBO, MCP**  
Vice President, Uniform Evaluation Service

**GP Russ Chaney**  
CEO, The IAPMO Group

For additional information about this evaluation report please visit [www.uniform-es.org](http://www.uniform-es.org) or email at [info@uniform-es.org](mailto:info@uniform-es.org).



## CALIFORNIA SUPPLEMENT

**VERCO DECKING, INC. a NUCOR Company**  
4340 North 42nd Avenue  
Phoenix, Arizona 85019  
(602) 272-1347  
[www.vercodeck.com](http://www.vercodeck.com)

## STEEL DECK PANELS

**CSI DIVISION: 05 00 00 – METALS**  
**CSI SECTION: 05 31 00 – STEEL DECK**  
    **05 31 13 – STEEL FLOOR DECKING**  
    **05 31 23 – STEEL ROOF DECKING**

### 1.0 RECOGNITION

Verco Decking Inc. Steel Deck Panels described in IAPMO UES ER-2018 and this supplement have been evaluated for use as components of floor and roof systems. The structural properties of the steel deck panels were evaluated for compliance with the following codes and regulations:

- 2019 and 2016 California Building Code (CBC)

### 2.0 LIMITATIONS

Use of the Verco Steel Deck Panels recognized in this report are subject to the following limitations:

- 2.1** Diaphragm deflections shall not exceed the permitted relative deflection of walls between the diaphragm level and the floor below. The flexibility limitations shown in Table 1604A.4 of the California Building Code may be used as a guide in lieu of a rational analysis of the anticipated deflections.
- 2.2** As applicable, in accordance with CBC Section 2210A.1.1.2, the minimum base steel thickness of the steel deck shall be 0.0359 inches (0.9 mm), except for single-story open structures, where the steel deck is not used as a diaphragm and there are no suspended hangers or bracing for nonstructural components attached to the deck.
- 2.3** Special Inspections are required in accordance with CBC Sections 1705.2 and 1705A.2, Steel Construction; and CBC Sections 1705.3 and 1705A.3, Concrete Construction.
- 2.4** Structural Observation is required in accordance with CBC Sections 1704.6 and 1704A.6.
- 2.5** Concrete tests and materials shall comply with CBC Sections 1909.2, 1903A, and 1910A, as applicable.

**For additional information about this evaluation report please visit [www.uniform-es.org](http://www.uniform-es.org) or email at [info@uniform-es.org](mailto:info@uniform-es.org)**





## LOS ANGELES SUPPLEMENT

**VERCO DECKING, INC. a NUCOR Company**  
4340 North 42nd Avenue  
Phoenix, Arizona 85019  
(602) 272-1347  
[www.vercodeck.com](http://www.vercodeck.com)

## STEEL DECK PANELS

**CSI DIVISION: 05 00 00 – METALS**  
**CSI SECTION: 05 31 00 – STEEL DECK**  
**05 31 13 – STEEL FLOOR DECKING**  
**05 31 23 – STEEL ROOF DECKING**

### 1.0 RECOGNITION

Verco Decking Inc. Steel Deck Panels described in IAPMO UES ER-2018 and this supplement have been evaluated for use as components of floor and roof systems. The structural properties of the steel deck panels were evaluated for compliance with the following codes and regulations:

- 2020 City of Los Angeles Building Code (LABC)
- 2020 City of Los Angeles Residential Code (LARC)

### 2.0 LIMITATIONS

Use of the Verco Steel Deck Panels recognized in ER-2018 and this supplement is subject to the following limitations:

- 2.1** Special Inspections are required in accordance with LABC Section 1705.2, Steel Construction and 1705.3, Concrete Construction.
- 2.2** Structural Observation is required in accordance with LABC Section 1704.6.
- 2.3** Computations and details demonstrating that the loads applied to the decks comply with this report shall be submitted to the Department of Building and Safety for approval. In accordance with LABC Section 106.3.3.2, computations and drawings shall be prepared and stamped by an engineer or architect licensed by the State of California for the type of service performed except as otherwise permitted by the Department of Building and Safety. In

accordance with LABC Section 106.3.3.3, for buildings exceeding 160 feet (49 m) computations and drawings shall be prepared and stamped by a structural engineer licensed by the State of California.

- 2.4** For each job where the deck units are specified, the following information shall be indicated on the plans submitted to the Department of Building and Safety for approval.: (a) Cross-section details of the deck panels; (b) fastener details, including deck welding or other fasteners at supports, at diaphragm boundaries parallel to flutes, at shear transfer elements, and at side seams if such fasteners are required; (c) minimum length of deck panels; and (d) design shears.
- 2.5** Deck welding shall be performed by Los Angeles City certified cold-formed steel welders. Prior to proceeding with the welding, the welders shall demonstrate to the Deputy Inspectors their ability to produce the prescribed weld satisfactorily. A sample of the deck material shall be welded to steel simulating the framing. The sample specimen shall then be twisted, and if the deck material tears or if the weld in torsion indicates the proper fusion area, the weld shall be considered satisfactory.
- 2.6** Admixtures containing calcium chloride or other corrosive materials shall not be used in the concrete mix for the slab.
- 2.7** Prior to placement of the concrete for the slab, the steel deck panels shall be cleaned and oil, grease and other materials which may adversely affect the bonding of the concrete to the deck shall be removed.
- 2.8** In structures with long term live loads (i.e., warehouses, computer rooms, file rooms, etc.), the allowable loads in the tables of ER-2018 shall be reduced to account for creep in the concrete.

For additional information about this evaluation report please visit [www.uniform-es.org](http://www.uniform-es.org) or email at [info@uniform-es.org](mailto:info@uniform-es.org)



### TABLE OF CONTENTS

Subject	Page
Profile Characteristics	8
Embossed Profiles	9
Sidelap Types	9
Perforated Profiles	10
Connections Through Perforated Material	11
Composite Steel Deck-Slab Coefficient, K	11
Support Connection Tension Flexibility	11
Support Connection Shear Rupture Strength	11
Diaphragm Shear Strength and Stiffness	12
Diaphragm Shear Strength and Stiffness of Structural Concrete Filled Steel Deck-Slabs	13
Steel Roof Deck Diaphragm Length for Differential Thermal Effects	14
Proprietary Fasteners	15-18
Maximum Diaphragm Shear between Openings Reinforced with Cold-Formed Steel Curbs	19
PLB-36 and HSB-36 Roof Deck Spans for Concentrated Loads	20
ITW Buildex SAMMYS X-Press Swivel Head® Connection	21
Definitions of Section Property Symbols	22-24
Panel Properties	25-54
PLB-36, HSB-36, HSB-36-SS, HSB-30-NS, PLB-36 FormLok, B-36 FormLok, B-36-SS FormLok	25-26
HSBR-30-NS, HSBR-36, HSBR-36-SS, BR-36 FormLok, BR-36-SS FormLok	27
PLN3-32, HSN3-32, HSN3-32-SS, HSN3-32-NS, PLN3-32 FormLok, N3-32 FormLok, N3-32-SS FormLok, N3-32-NS FormLok	28-29
PLN-24, N-24, N-24-SS, PLN-24 FormLok, N-24 FormLok, N-24-SS FormLok	30-31
PLW2-36 FormLok, W2-36 FormLok, W2-36-SS FormLok	32
PLW3-36 FormLok, W3-36 FormLok, W3-36-SS FormLok	33
9/16 Shallow Vercor, 9/16 Shallow Vercor Inverted	34
1-5/16 Deep Vercor, 1-5/16 Deep Vercor Inverted	35
PLB-36 AC, HSB-36 AC, HSB-36-SS AC	36
PLN3-32 AC, HSN3-32 AC, HSN3-32-SS AC, HSN3-32-NS AC	37
PLN-24 AC, N-24 AC, N-24-SS AC	38
PLB-36 FP11, HSB-36 FP11, HSB-36-SS FP11	39
PLN3-32 FP11, HSN3-32 FP11, HSN3-32-SS FP11	40
PLN-24 FP11, N-24 FP11, N-24-SS FP11	41
PLB-36 FP21, HSB-36 FP21, HSB-36-SS FP21, HSB-30-NS FP21	42
PLN3-32 FP21, HSN3-32 FP21, HSN3-32-SS FP21	43
PLN-24 FP21, N-24 FP21, N-24-SS FP21	44
PLBCD-36, HSBCD-36, PLBCD-36 FormLok, BCD-36 FormLok	45
PLN3CD-32, HSN3CD-32, PLN3CD-32 FormLok, N3CD-32 FormLok	46
PLNCD-24, NCD-24, PLNCD-24 FormLok, NCD-24 FormLok	47
PLW2CD-36 FormLok, W2CD-36 FormLok	48
PLW3CD-36 FormLok, W3CD-36 FormLok	49
PLBCD-36 AC, HSBCD-36 AC, PLBCD-36 AC FormLok, BCD-36 AC FormLok	50
PLN3CD-32 AC, HSN3CD-32 AC, PLN3CD-32 AC FormLok, N3CD-32 AC FormLok	51
PLNCD-24 AC, NCD-24 AC, PLNCD-24 AC FormLok, NCD-24 AC FormLok	52
PLW2CD-36 AC FormLok, W2CD-36 AC FormLok	53
PLW3CD-36 AC FormLok, W3CD-36 AC FormLok	54



PROFILE CHARACTERISTICS										
Profile Designation(s)	Sidelap Type		Sidelap Fastener			Embossed	Cellular	Acoustic		
	Inter-locking	Nestable	VSC2	Screws	Other <sup>1</sup>			Web Perforated	Fully Perforated	Perforated Bottom Pan
PLB-36, PLN3-32, PLN-24	✓		✓							
HSB-36, HSN3-32, N-24	✓				✓					
HSB-36-SS, HSB-36-SS, HSN3-32-SS, N-24-SS	✓			✓						
HSB-30-NS, HSB-30-NS, HSN3-32-NS, 9/16 Shallow Vercor, 1-5/16 Deep Vercor		✓		✓	✓					
PLB-36 FormLok, PLN3-32 FormLok, PLN-24 FormLok, PLW2-36 FormLok, PLW3-36 FormLok	✓		✓			✓				
B-36 FormLok, BR-36 FormLok, N3-32 FormLok, N-24 FormLok, W2-36 FormLok, W3-36 FormLok	✓				✓	✓				
B-36-SS FormLok, BR-36-SS FormLok, N3-32-SS FormLok, N-24-SS FormLok, W2-36-SS FormLok, W3-36-SS FormLok	✓			✓		✓				
N3-32-NS FormLok		✓		✓	✓	✓				
PLB-36 AC, PLN3-32 AC, PLN-24 AC	✓		✓					✓		
HSB-36 AC, HSN3-32 AC, N-24 AC	✓				✓			✓		
HSB-36-SS AC, HSN3-32-SS AC, N-24-SS AC	✓			✓				✓		
HSN3-32-NS AC		✓		✓				✓		
PLB-36 FP11, PLB-36 FP21, PLN3-32 FP11, PLN3-32 FP21, PLN-24 FP11, PLN-24 FP21	✓		✓						✓	
HSB-36 FP11, HSB-36 FP21, HSN3-32 FP11, HSN3-32 FP21, N-24 FP11, N-24 FP21	✓				✓				✓	
HSB-36-SS FP11, HSB-36-SS FP21, HSN3-32-SS FP11, HSN3-32-SS FP21, N-24-SS FP11, N-24-SS FP21	✓			✓					✓	
PLBCD-36, PLN3CD-32, PLNCD-24	✓		✓				✓			
HSBCD-36, HSN3CD-32, NCD-24	✓				✓		✓			
PLBCD-36 FormLok, PLN3CD-32 FormLok, PLNCD-24 FormLok, PLW2CD-36 FormLok, PLW3CD-36 FormLok	✓		✓			✓	✓			
BCD-36 FormLok, N3CD-32 FormLok, NCD-24 FormLok, W2CD-36 FormLok, W3CD-36 FormLok	✓				✓	✓	✓			
PLBCD-36 AC, PLN3CD-32 AC, PLNCD-24 AC	✓		✓				✓			✓
HSBCD-36 AC, HSN3CD-32 AC, NCD-24 AC	✓				✓		✓			✓
PLB-CD AC FormLok, PLN3-CD AC FormLok, PLW2-CD AC FormLok, PLW3-CD AC FormLok	✓		✓			✓	✓			✓
BCD-36 AC FormLok, N3CD-32 AC FormLok, NCD-24 AC FormLok, W2CD-36 AC FormLok, W3CD-36 AC FormLok	✓				✓	✓	✓			✓

1. Other = Top arc seam sidelap welds or non-piercing button punch sidelap connections for interlocking profiles and arc spot or fillet welds for nestable profiles.





EMBOSSED PROFILES		
Profiles	End View	Side View
PLB FormLok, HSB FormLok, B FormLok-SS, BR FormLok-SS, PLB-CD FormLok, B-CD FormLok, PLB-CD AC FormLok, B-CD AC FormLok		
PLN3 FormLok, N3 FormLok, N3 FormLok-SS, N3 FormLok-NS, PLN3-CD FormLok, HSN3-CD FormLok, PLN3-CD AC FormLok, HSN3-CD AC FormLok		
PLN FormLok, N FormLok, N FormLok-SS, PLN-24-CD FormLok, N-CD FormLok, PLN-CD AC FormLok, N-CD AC FormLok		
PLW2 FormLok, W2 FormLok, W2 FormLok-SS, PLW2-CD FormLok, W2-CD FormLok, PLW2-CD AC FormLok, W2-CD AC FormLok		
PLW3 FormLok, W3 FormLok, W3 FormLok-SS, PLW3-CD FormLok, W3-CD FormLok, PLW3-CD AC FormLok, W3-CD AC FormLok	OPTION 1   OPTION 2 	  

SIDELAP TYPES			
Interlocking (PunchLok II, Other)	Interlocking (Screwed Sidelap)	Nestable (Screwed Sidelap)	Nestable (Vercor)



### PERFORATED PROFILES

#### Perforated Web Reduction Factor

The perforated web reduction factor,  $q_s$ , is calculated as follows:

$$q_s = 1 - (1 - k) \left( \frac{W_p}{h_w} \right) \quad [\text{Eq. W-1}]$$

$$p_o = 0.9069 \left( \frac{d_p^2}{c_p^2} \right) \quad [\text{Eq. W-2}]$$

$$\begin{aligned} k &= 1 - 2.175p_o \text{ for } p_o < 0.20 \\ k &= 0.9 + p_o^2 - 1.875p_o \text{ for } 0.20 \leq p_o \leq 0.58 \end{aligned} \quad [\text{Eq. W-3}]$$

Where:

$q_s$  = Perforated web reduction factor

$k$  = Ratio of stiffness

$W_p$  = Width of perforated band in web, in.

$h_w$  = Flat dimension of web measured in plane of web, in.

$p_o$  = Percentage of open area

$d_p$  = Diameter of perforation hole, in.

$c_p$  = Perforation hole center-to-center spacing, in.

#### Shear Strength of Profiles with Perforated Webs

The vertical shear strength for profiles with perforated webs shall be calculated as follows:

$$V_{np} = q_s n_w V_n \sin\theta \quad [\text{Eq. W-4}]$$

Where:

$V_{np}$  = Vertical shear strength of profile with perforated web, kip/ft

$n_w$  = Number of webs per foot

$V_n$  = The nominal shear strength of solid web calculated in accordance with AISI S100-16 Sec. G2.1, kips

$\theta$  = Angle between plane of web and plane of bearing surface, deg

#### Web-Crippling Strength of Profiles with Perforated Webs

The web-crippling strength of a perforated web shall be calculated in accordance with AISI S100-16 Sec. G5 with the following modified equation:

$$P_n = Ct^2 F_y \cdot \sin\theta \cdot \left( 1 - C_R \sqrt{\frac{R}{t}} \right) \left( 1 + C_N \sqrt{\frac{N}{t}} \right) \left( 1 - C_h \sqrt{\frac{h_w}{q_s t}} \right) \quad [\text{AISI S100-16 Eq. G5-1}]$$

*(Modified)*

All variables are as defined in AISI S100-16 Section G5



CONNECTIONS THROUGH PERFORATED MATERIAL <sup>1</sup>						
Fastener Property	Fastener	Adjustment Factor, $\rho$	Individual Connections		Diaphragms	
			$\Omega$ (ASD)	$\phi$ (LRFD)	$\Omega$ (ASD)	$\phi$ (LRFD)
Nominal Shear Strength	Screw	1.00	3.00	0.50	Per AISI S310 Table B1.1	
	PAF <sup>2</sup>	$2.76t + 0.58 \leq 1.00$	2.75	0.60		
	Weld <sup>3</sup>	$0.99d + 0.05 \leq 1.00$	2.80	0.55		
Nominal Pullover Strength	Screw, PAF	0.85	3.00	0.50		
Nominal Tension Strength	Weld <sup>2,4</sup>	$0.19tF_u + 0.11 \leq 1.00$	3.00	0.50		
Flexibility	Screw	1.71	-			
	PAF	1.15				
	Weld	1.00				

<sup>1</sup> For connections through perforated material, multiply calculated fastener property by appropriate adjustment factor.

<sup>2</sup>  $t$  = Base steel thickness of panel (in.)

<sup>3</sup>  $d$  = Visible diameter of arc spot weld (in.)

<sup>4</sup>  $F_u$  = Tensile strength of sheet steel (ksi)

### COMPOSITE STEEL DECK-SLAB COEFFICIENT, K

The flexural strength for composite steel floor deck slabs utilizing steel deck panels be designed in accordance with ANSI/SDI C-2017 Section A2.2 where:

$$K = 2.03 - 1.31 \left( \frac{h_c}{h - y_b} \right) \geq K_{\min} \quad [\text{Eq. K-1}]$$

Where:

$h_c$  = Thickness of concrete cover (in.)

$h$  = Total thickness of deck slab (in.)

$y_b$  = Distance from extreme bottom fiber to neutral axis of gross section (in.)

$K_{\min}$  = Minimum composite steel-deck slab coefficient per section property tables

### SUPPORT CONNECTION TENSION FLEXIBILITY

The flexibility of support connection in tension shall be determined in accordance with Eq. T-1:

$$S_t = 1 / (1706 \cdot t^2 \cdot d_w + 2.51) \quad [\text{Eq. T-1}]$$

Where:

$S_t$  = Structural support connection tension flexibility (in/k)

$d_w$  = Diameter of support connection or fastener (in.)

$t$  = Base steel thickness of panel (in.)

### SUPPORT CONNECTION SHEAR RUPTURE STRENGTH

The support connection shear rupture strength for the steel deck shall be determined in accordance with Eq. R-1:

$$P_{nv} = 2 \cdot F_u \cdot t \cdot (e - d/2) \quad \Omega = 2.75 \text{ (ASD)} \quad \phi = 0.60 \text{ (LRFD)} \quad \phi = 0.60 \text{ (LSD)} \quad [\text{Eq. R-1}]$$

Where:

$P_{nv}$  = Nominal support connection shear rupture strength (kips)

$F_u$  = Tensile strength of sheet steel (ksi)

$t$  = Base steel thickness of panel (in.)

$e$  = Distance between center of connection and edge of sheet (parallel to force) (in.)

$d$  = Visible weld diameter or fastener shank diameter (in.)



### DIAPHRAGM SHEAR STRENGTH AND STIFFNESS

Diaphragm shear strength and stiffness shall be calculated per AISI S310-16 with the following modifications:

#### **D1 Diaphragm Shear Strength per Unit Length Controlled by Connection Strength, $S_{nf}$**

The nominal shear strength [resistance] per unit length of a diaphragm controlled by connection strength,  $S_{nf}$ , shall be the smallest of  $S_{ni}$ ,  $S_{nc}$ ,  $S_{ne}$ , and  $S_{np}$ .

$$S_{np} = \text{minimum} \left( n_d P_{nf} \frac{12}{w_t} \right) \quad \begin{array}{l} \text{[Eq. D1-4a]} \\ \text{For Fluted Panels} \end{array} \quad S_{np} = NP_{nf} \quad \begin{array}{l} \text{[Eq. D1-4b]} \\ \text{For Cellular Deck} \end{array}$$

Where

- $S_{np}$  = Nominal shear strength [resistance] per unit length of diaphragm controlled by connections along the edge perpendicular to the panel span and located at exterior support, kip/ft
- $n_d$  = Number of support connections at any given bottom flute along a panel end perpendicular to the panel span and located at exterior support
- $w_t$  = Greatest tributary width to any given bottom flute with support connections along the edge perpendicular to the panel span and located at exterior support, in.

All other variables are as defined in AISI S310-16 Section D1

#### **D2.1 Fluted Panel**

The nominal diaphragm shear strength [resistance] per unit length,  $S_{nb}$ , for either acoustic or non-acoustic fluted panels shall be the smallest of  $S_{no}$ , and  $S_{ni}$ .

$$S_{no} = \alpha \frac{7890}{L_v^2} \left( \frac{I_{xg}^3 t^3 d}{s} \right)^{0.25} \quad \text{[Eq. D2.1-1]} \quad S_{ni} = P_n \frac{d - e}{D_d} \left( \frac{12}{d} \right) \quad \text{[Eq. D2.1-2]}$$

Where

- $\alpha$  = 1.00 for panels fastened to support at every bottom flute at exterior supports
- 0.75 for panels not fastened to support at every bottom flute at exterior supports

$S_{no}$  = Nominal diaphragm shear strength [resistance] per unit length controlled by panel out-of-plane buckling, kip/ft

$S_{ni}$  = Nominal diaphragm shear strength [resistance] per unit length controlled by exterior support local web buckling, kip/ft

$d$  = Panel corrugation pitch, in.

$e$  = One-half the bottom flat width of panel measured between points of intercept, in.

$D_d$  = Depth of panel, in.

$$P_n = 4.36t^2 F_y \cdot \sin \theta \cdot \left( 1 - 0.04 \sqrt{\frac{R}{t}} \right) \left( 1 + 0.25 \sqrt{\frac{N_e}{t}} \right) \left( 1 - 0.025 \sqrt{\frac{h_w}{q_s t}} \right) \quad \text{[Eq. D2.1-3]}$$

Where

$t$  = Base steel thickness of panel, in.

$F_y$  = Design yield stress, ksi

$\theta$  = Angle between plane of web and plane of bearing surface, deg.

$R$  = Inside bend radius, in.

$N_e$  = Bearing Length at end of panel support, in.

$h_w$  = Flat dimension of web measured in plane of web, in.

$q_s$  = Perforated web reduction factor

#### **D5.1.1 Stiffness of Fluted Panels**

The diaphragm stiffness,  $G'$  shall be calculated in accordance with modified AISI S310-16 Eq. D5.1.1-1

$$G' = \left( \frac{Et}{2(1 + \mu) \frac{s}{d} + \gamma_c \alpha D_n + C} \right) K \quad \text{[Eq. D5.1.1-1]} \quad \begin{array}{l} \text{Where } \alpha = 1.00 \text{ for panels with butted end laps at both ends} \\ 0.50 \text{ for panels with butted end laps at one end} \\ 0.00 \text{ for panels with lapped end laps at both ends} \end{array}$$

For spacing of fasteners connecting panels along longitudinal edges parallel to the deck flutes greater than the interior side-lap seam fastener spacing:

$$d_e \leq \frac{S_s}{S_f} d_s \quad \text{[Eq. G]}$$

Where:

- $d_e$  = Spacing of parallel edge fasteners
- $d_s$  = Spacing of sidelap fasteners
- $S_s$  = Sidelap connection flexibility (in/kip)
- $S_f$  = Structural support connection flexibility (in/k)



### DIAPHRAGM SHEAR STRENGTH AND STIFFNESS OF STRUCTURAL CONCRETE FILLED STEEL DECK-SLABS

For structural concrete deck-slabs with a concrete thickness above the top of the deck no less than 2 in. or greater than 6 in., the nominal shear strength per unit length of diaphragms with structural concrete fill is calculated in accordance with Eq. C-1 and the diaphragm stiffness is calculated in accordance with Eq. C-4.

$$S_n = S_c + S_f \quad \Omega = 2.00 \text{ (ASD)} \quad \phi = 0.80 \text{ (LRFD)} \quad \phi = 0.70 \text{ (LSD)} \quad [\text{Eq. C-1}]$$

$$S_c = k_c \cdot \lambda \cdot b \cdot \left[ \left( D_c + \frac{D_d}{2} \right) + t \cdot \left( \frac{E}{E_c} \right) \cdot \left( \frac{d}{s} \right) \right] \cdot \sqrt{f'_c} \quad [\text{Eq. C-2}]$$

$$\begin{aligned} \text{For } D \geq 35 \text{ pcy, } S_f &= 0.37 \cdot f_{150} \cdot \left( D_c + \frac{D_d}{2} \right) \quad [\text{Eq. C-3}] \\ \text{For } D < 35 \text{ pcy, } S_f &= 0.00 \end{aligned}$$

$$G' = 4.8 \cdot \left[ \left( D_c + \frac{D_d}{2} \right) + t \cdot \left( \frac{E}{E_c} \right) \cdot \left( \frac{d}{s} \right) \right] \cdot \sqrt{f'_c} \quad [\text{Eq. C-4}]$$

For structural concrete deck-slabs utilizing Verco deck profiles and Bekaert Dramix 4D 65/60 BG Steel Fibers installed in accordance with IAPMO UES ER-465, steel fiber reinforced concrete properties are determined in accordance with Eq. BD-1

For  $20 \text{ pcy} \leq D \leq 66 \text{ pcy}$

$$f_{r1}, f_{r4}, f_{150}, R_{T,150}^D = C_1 \cdot \left( \frac{D}{\sqrt{f'_c}} \right)^2 + C_2 \cdot \left( \frac{D}{\sqrt{f'_c}} \right) \quad [\text{Eq. BD-1}]$$

	$f_{r1}$	$f_{r4}$	$f_{150}$	$R_{T,150}^D$
$C_1$	-81	-127	-127	-30
$C_2$	537	507	507	105

Where:

$S_n$  = Nominal shear strength per unit length of diaphragm system with concrete fill, k/ft (kN/m)

$S_c$  = Shear strength of steel deck and structural concrete calculated in accordance with Eq. C-2, k/ft (kN/m)

$S_f$  = Bekaert Dramix® steel fiber contribution to shear strength calculated in accordance with Eq. C-3, k/ft (kN/m)

$G'$  = Shear stiffness of concrete deck-slab diaphragm, k/in

$k_c$  = Factor for structural concrete strength = 3.2/1000 for U.S. customary units and 0.266/1000 for SI units

$\lambda$  = 1.00 for normal weight concrete and 0.75 for lightweight concrete

$b$  = Unit width of diaphragm with structural concrete fill = 12 in. for U.S. customary units and 1000 mm for SI units

$D_c$  = Depth of concrete cover above steel deck flutes, in. (mm)

$D_d$  = Depth of steel deck, in. (mm)

$D$  = Fiber dosage, pcy

$t$  = Base steel thickness of panel, in. (mm)

$E$  = Modulus of elasticity of steel

$E_c$  = Modulus of elasticity of concrete in accordance with ACI 318

$d$  = Panel corrugation pitch, in. (mm)

$s$  = Developed flute width of single corrugation, in. (mm)

$f'_c$  = Structural concrete compressive strength, psi (Mpa)  $\geq 2500$  psi (17.2 MPa)

$f_{150}$  = Stress at L/150 (psi)

All other variables as defined in IAPMO UES ER-465

### STRUCTURAL CONCRETE FILLED STEEL DECK-SLAB SHEAR TRANSFER TO CHORDS AND COLLECTORS

Shear transfer of structural concrete fill deck-slab to chords and collectors shall be in accordance with AISI S310-16 Section D4.4 including D4.4.1 with safety and resistance factors for connections of the composite deck slab to supports as follows:

- Steel headed stud anchors with nominal shear strength determined in accordance with AISC 360 with the following factors:  
 $\Omega = 3.00$  (ASD)       $\phi = 0.55$  (LRFD)       $\phi = 0.50$  (LSD)
- Available strength [factored resistance] for Shearflex standoff screw fastener shall be determined in accordance with this report,  $\Omega$  and  $\phi$  are listed on Page 15 of this report.
- Available strength [factored resistance] for welds shall be determined in accordance with AISI S100-16.
- Available strength [factored resistance] for screws shall be determined in accordance with AISI S100-16.
- Available strength [factored resistance] for proprietary fasteners shall be determined in accordance with this report,  $\Omega$  and  $\phi$  are listed on Page 17 of this report.



## STEEL ROOF DECK DIAPHRAGM LENGTH FOR DIFFERENTIAL THERMAL EFFECTS

The length,  $L$ , and width,  $b$ , of the roof diaphragm, in accordance with the definition sections of the IBC or ASCE 7, including the steel roof deck, support members (framing), chords and collectors shall be permitted to be of unlimited length between joints for differential thermal expansion or contraction (thermal expansion joints) provided the following conditions exist:

- a. Vertical Load system, including the vertical lateral force resisting system, does not have Building Separation Joints, Seismic Joints, Expansion joints or similar joints that interrupt the diaphragm chord with respect to the area of the diaphragm under consideration.
- b. Wall systems, both perimeter and interior, to be constructed as continuous walls, individual wall panels, or wall segments. Individual wall panels or wall segments are permitted to be precast concrete walls, site cast concrete walls, tilt-up concrete walls, masonry walls with or without crack control joints, stud wall system with or without crack control joints, or wind girt framed wall systems with or without crack control joints. A combination of these systems may be used. See Figures A and B.
- c. Diaphragm has continuous chord members and a positive load path capable of transferring diaphragm forces between the diaphragm and the Vertical Lateral Force Resisting System.
- d. Steel Roof Deck Diaphragm is covered by a roofing membrane system; deck is not directly exposed to sun or elements in final occupied condition.
- e. Steel roof deck support members consists of one or a combination of the following.
  1. Vulcraft Open Web Steel Joists and Joist Girders in accordance with SJI-100.
  2. Structural Steel members in accordance with AISC 360.
  3. Cold-Formed Steel members in accordance with AISI S100.
  4. Bearing walls.
- f. Steel Roof Deck Diaphragm Attachment:
  1. Sidelap Connection: PunchLok II System with VSC2 sidelap connections.
  2. Connection to Supports: Hilti X-HSN 24 or X-ENP-19 Power Actuated Fasteners.

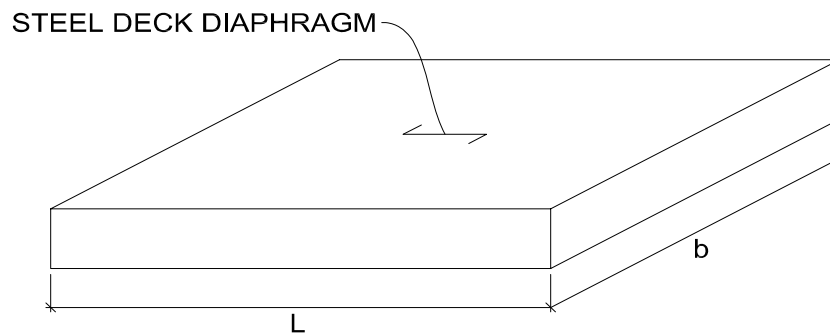

Figure A: Structure with Continuous Walls

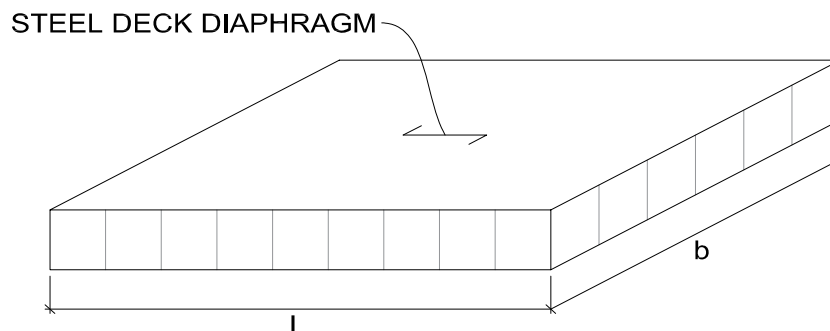

Figure B: Structure with Individual Wall Panels or Wall Segments

### PROPRIETARY FASTENERS

#### **PunchLok II System**

The nominal shear strength [resistance] for PunchLok II System (VSC2) connection shall be determined in accordance with Eq. PL-1:

$$P_{ns} = 137.42 \cdot t - 2.01 \quad [\text{Eq. PL-1}]$$

The flexibility of PunchLok II System (VSC2) connection shall be determined in accordance with Eq. PL-2:

$$S_s = \frac{0.012}{1000 \cdot t^2} \quad [\text{Eq. PL-2}]$$

- ① PunchLok® II system connection - as shown the 2 deformations of male and female sheets are projecting through the female sheet. However, the VSC2 may be made in either direction
- ② Sheared surface of male leg.
- ③ Sheared surface of female leg.
- ④ Male leg / sheet.
- ⑤ Female leg / sheet.

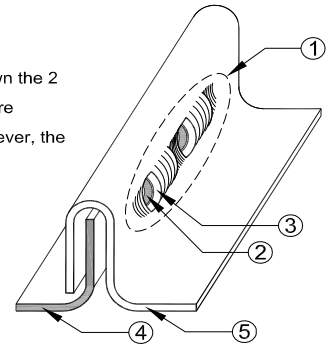

#### **Simpson Strong-Tie**

The nominal shear strength [resistance] for the Simpson XL Screw shall be determined in accordance with Eq. S-1:

$$P_{nf} = 78 \cdot t \cdot (t_{\text{support}})^{0.15} \leq P_{nvs} \quad [\text{Eq. S-1}]$$

The nominal shear strength [resistance] for the Simpson XM Screw shall be determined in accordance with Eq. S-2a or S-2b:

$$\text{For } t_{\text{support}} \leq 0.1875 \text{ in} \quad P_{nf} = 240 \cdot (t)^{1.5} \leq P_{nvs} \quad [\text{Eq. S-2a}]$$

$$\text{For } t_{\text{support}} > 0.1875 \text{ in} \quad P_{nf} = 53 \cdot t \leq P_{nvs} \quad [\text{Eq. S-2b}]$$

The nominal shear strength [resistance] for the Simpson X1S1016 or XQ1S1016 shall be determined in accordance with Eq. S-3:

$$P_{ns} = 20 \cdot t \leq 1.625 \quad [\text{Eq. S-3}]$$

The nominal shear strength [resistance] for the Simpson XU34B1016 shall be determined in accordance with Eq. S-4:

$$P_{ns} = 25.2 \cdot t \leq 1.735 \quad [\text{Eq. S-4}]$$

Where:

$t$  = Base steel thickness of panel (in.)

$t_{\text{support}}$  = Thickness of support (in.)

$S_s$  = Sidelap connection flexibility (in/kip)

$S_f$  = Structural support connection shear flexibility (in/k)

$P_{nf}$  = Nominal shear strength [resistance] of a support connection (kips)

$P_{ns}$  = Nominal shear strength [resistance] of a side-lap connection per fastener (kips)

$P_{nvs}$  = Nominal shear strength [resistance] of screw



### PROPRIETARY FASTENERS (Continued)

#### Hilti

The nominal shear strength [resistance] for the Hilti X-ENP-19 L15 PAF shall be determined in accordance with Eq. H-1:

$$P_{nf} = 56 \cdot t \cdot (1 - t) \leq P_{nvp} \quad [\text{Eq. H-1}]$$

The nominal shear strength [resistance] for the Hilti X-HSN24 PAF shall be determined in accordance with Eq. H-2:

$$P_{nf} = 52 \cdot t \cdot (1 - t) \leq P_{nvp} \quad [\text{Eq. H-2}]$$

The flexibility of the Hilti X-ENP-19 L15 shall be determined in accordance with Eq. H-3a:

$$S_f = \frac{0.75}{1000\sqrt{t}} \quad [\text{Eq. H-3a}]$$

The flexibility of the Hilti X-HSN24 PAF shall be determined in accordance with Eq. H-3b:

$$S_f = \frac{1.25}{1000\sqrt{t}} \quad [\text{Eq. H-3b}]$$

The nominal tension strength [resistance] for the Hilti X-HSN 24 controlled by pull-out shall be determined in accordance with Eq. H-4:

$$P_{not} = 8 \cdot t_{\text{support}} + 0.088 \leq 1.875 \quad \Omega = 2.50 \text{ (ASD)} \quad \phi = 0.65 \text{ (LRFD)} \quad \phi = 0.55 \text{ (LSD)} \quad [\text{Eq. H-4}]$$

The nominal tension strength [resistance] for the X-ENP-19 L15 controlled by pull-out shall be determined in accordance with Eq. H-5:

$$P_{not} = 2.625 \quad \Omega = 2.50 \text{ (ASD)} \quad \phi = 0.65 \text{ (LRFD)} \quad \phi = 0.55 \text{ (LSD)} \quad [\text{Eq. H-5}]$$

#### Shearflex Standoff Screws

The nominal shear strength [resistance] for the Shearflex Standoff Screw shall be determined in accordance with Eq. F-1 or F-2:

For PLB, HSB, PLB FormLok, B FormLok, PLBCD, HSBCD, PLBCD FormLok, BCD FormLok and 1-5/16 Deep Vercor

$$P_{nf} = 4.650 \quad \Omega = 2.85 \text{ (ASD)} \quad \phi = 0.55 \text{ (LRFD)} \quad \phi = 0.45 \text{ (LSD)} \quad [\text{Eq. F-1}]$$

For HSBR, and BR FormLok

$$P_{nf} = 7.044 \quad \Omega = 2.85 \text{ (ASD)} \quad \phi = 0.55 \text{ (LRFD)} \quad \phi = 0.45 \text{ (LSD)} \quad [\text{Eq. F-2}]$$

Where:

t = Base steel thickness of panel (in.)

t<sub>support</sub> = Thickness of support (in.)

S<sub>f</sub> = Structural support connection flexibility (in/k)

P<sub>nf</sub> = Nominal shear strength [resistance] of a support connection (kips)

P<sub>ns</sub> = Nominal shear strength [resistance] of a side-lap connection per fastener (kips)

P<sub>nvp</sub> = Nominal shear strength [resistance] of PAF (see page 15)

P<sub>not</sub> = Nominal tensile strength [resistance] of a support connection per fastener controlled by pull-out (kips)



### PROPRIETARY FASTENERS (Continued)

#### **Pneutek**

The nominal shear strength [resistance] for the Pneutek SDK61 PAF shall be determined in accordance with Eq. P-1a and P-1b:

For substrate thickness equal to 0.113"

$$P_{nf} = 0.735 \cdot t \cdot F_u(1 - 0.016 \cdot t \cdot F_u) \leq P_{nvp} \quad [\text{Eq. P-1a}]$$

For substrate thickness equal to 0.155"

$$P_{nf} = 0.788 \cdot t \cdot F_u(1 - 0.028 \cdot t \cdot F_u) \leq P_{nvp} \quad [\text{Eq. P-1b}]$$

For substrate thickness between 0.113" and 0.155",  $P_{nf}$  shall be determined by interpolation.

The nominal shear strength [resistance] for the Pneutek SDK63, K64 and K66 PAF shall be determined in accordance with Eq. P-2:

$$P_{nf} = 1.264 \cdot t \cdot F_u(1 - 0.053 \cdot t \cdot F_u) \leq P_{nvp} \quad [\text{Eq. P-2}]$$

The flexibility of the Pneutek SDK61 PAF shall be determined in accordance with Eq. P-3:

$$S_f = \frac{3}{1000\sqrt{t}} \quad [\text{Eq. P-3}]$$

The flexibility of the Pneutek SDK63, K64 and K66 PAF shall be determined in accordance with Eq. P-4a and P-4b:

For substrate thickness less than 0.25"

$$S_f = \frac{3}{1000\sqrt{t}} \quad [\text{Eq. P-4a}]$$

For substrate thickness equal to or greater than 0.25"

$$S_f = \frac{1}{1000\sqrt{t}} \quad [\text{Eq. P-4b}]$$

The nominal tension strength [resistance] for the Pneutek SDK61, SDK63, K64 and K66 PAF controlled by pull-out shall be determined in accordance with Eq. P-5:

$$P_{not} = 18.37 \cdot t_{support} \leq 4.811 \quad \Omega = 2.45 \text{ (ASD)} \quad \phi = 0.65 \text{ (LRFD)} \quad \phi = 0.55 \text{ (LSD)} \quad [\text{Eq. P-5}]$$

Where:

$P_{nf}$  = Nominal shear strength [resistance] of a support connection per fastener (kips)

$t$  = Base steel thickness of panel (in.)

$F_u$  = Tensile strength of sheet steel (ksi)

$P_{nvp}$  = Nominal shear strength [resistance] of PAF (see page 15)

$P_{not}$  = Nominal tensile strength [resistance] of a support connection per fastener controlled by pull-out (kips)

$t_{support}$  = Thickness of support (in.)

$S_f$  = Structural support connection flexibility (in/k)

$\phi$  = Resistance Factor

$\Omega$  = Safety Factor



PROPRIETARY SUPPORT FASTENER PROPERTIES <sup>1-4</sup>								
Specified Properties	Hilti		Pneutek				Simpson Strong-Tie	
	X-HSN 24	X-ENP-19	SDK61	SDK63	K64	K66	XM Screw	XL Screw
Minimum Substrate Thickness (in)	0.125	0.250	0.113	0.155	0.187	0.281	0.125	0.125
Maximum Substrate Thickness (in)	0.375	∞	0.155	0.250	0.312	∞	0.610	0.610
Shank Diameter (in)	0.157	0.177	0.144	0.173	0.181	0.199	0.216	0.216
Head or Washer Diameter (in)	0.474	0.591	0.500	0.500	0.500	0.500	0.483	0.625
Nominal Tensile Strength based on Material strength, $P_{nts}$ (kip) <sup>1</sup>	5.033 $\Omega = 2.65$ (ASD) $\phi = 0.60$ (LRFD) $\phi = 0.50$ (LSD)	6.397	3.909	5.641 $\Omega = 2.65$ (ASD) $\phi = 0.60$ (LRFD) $\phi = 0.50$ (LSD)	6.175	7.465	4.985 $\Omega = 3.00$ (ASD) $\phi = 0.50$ (LRFD) $\phi = 0.40$ (LSD)	4.985
Nominal Shear Strength of Screw based on Material Strength, $P_{nvs}$ (kip) <sup>2</sup>	-	-	-	-	-	-	3.110 $\Omega = 3.00$ (ASD) $\phi = 0.50$ (LRFD) $\phi = 0.40$ (LSD)	3.110
Nominal Shear Strength of PAF based on Material Strength, $P_{nvp}$ (kip) <sup>3</sup>	3.020 $\Omega = 2.65$ (ASD) $\phi = 0.60$ (LRFD) $\phi = 0.50$ (LSD)	3.838	2.345	3.385 $\Omega = 2.65$ (ASD) $\phi = 0.60$ (LRFD) $\phi = 0.50$ (LSD)	3.705	4.479	-	-
Individual Fastener Shear Strength, $P_{nf}$ <sup>4</sup>	$\Omega = 2.30$ (ASD) $\phi = 0.70$ (LRFD) $\phi = 0.55$ (LSD)			$\Omega = 2.40$ (ASD) $\phi = 0.65$ (LRFD) $\phi = 0.55$ (LSD)			$\Omega = 3.00$ (ASD) $\phi = 0.50$ (LRFD) $\phi = 0.40$ (LSD)	

<sup>1</sup> Determined in accordance with AISI S100-16 Section J5.2.1 and J4.4.3

<sup>2</sup> Determined in accordance with AISI S100-16 Section J4.3.2

<sup>3</sup> Determined in accordance with AISI S100-16 Section J5.3.1

<sup>4</sup> For use when calculating individual fastener shear strength in accordance with equations listed on pages 15-17 of this report.

<sup>5</sup> The shear strength of the connection shall be the minimum of the allowable strength for ASD, the design strength for LRFD, or the factored strength for LSD of the individual fastener shear strength and the shear strength based on material strength.





MAXIMUM DIAPHRAGM SHEAR BETWEEN OPENINGS REINFORCED WITH COLD-FORMED STEEL CURBS <sup>1,2a-f</sup>							
Deck Profile	Deck Gage	ASD - Allowable Diaphragm Shear, $S_n/\Omega$ (plf)			LRFD - Design Diaphragm Shear, $\phi S_n$ (plf)		
		Span Length (ft-in)			Span Length (ft-in)		
		6'-0"	8'-0"	10'-0"	6'-0"	8'-0"	10'-0"
PLB-36 HSB-36	22	1127	1116	-	1831	1814	-
	20	1408	1398	1313	2288	2272	2134
	18	1929	1920	1914	3135	3120	3110

<sup>1</sup>  $S_n$  = Nominal shear strength [resistance] per unit length of diaphragm system

<sup>2</sup> Roof openings may be reinforced with cold-formed steel curbs on top of the steel roof deck without below deck support frames, as shown below subject to the following conditions a-f:

- <sup>a</sup> The diaphragm shear strengths shall not exceed the lesser of this table or the calculated shear strength.
- <sup>b</sup> Opening shall span between joists or beams shown in figure below.
- <sup>c</sup> Cold-formed steel curbs be shall be a minimum of ASTM A653 Commercial Quality or equivalent steel specification.
- <sup>d</sup> Cold-Formed steel curbs shall meet the dimensions as shown in figure below.
- <sup>e</sup> Cold-Formed steel curbs shall have the minimum attachments to the steel roof deck as shown in figure below.
- <sup>f</sup> Deck may be end lapped, butted, or continuous between openings.

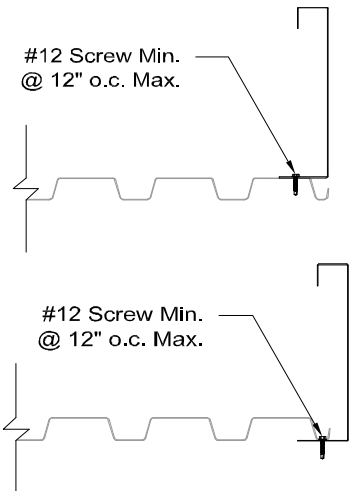
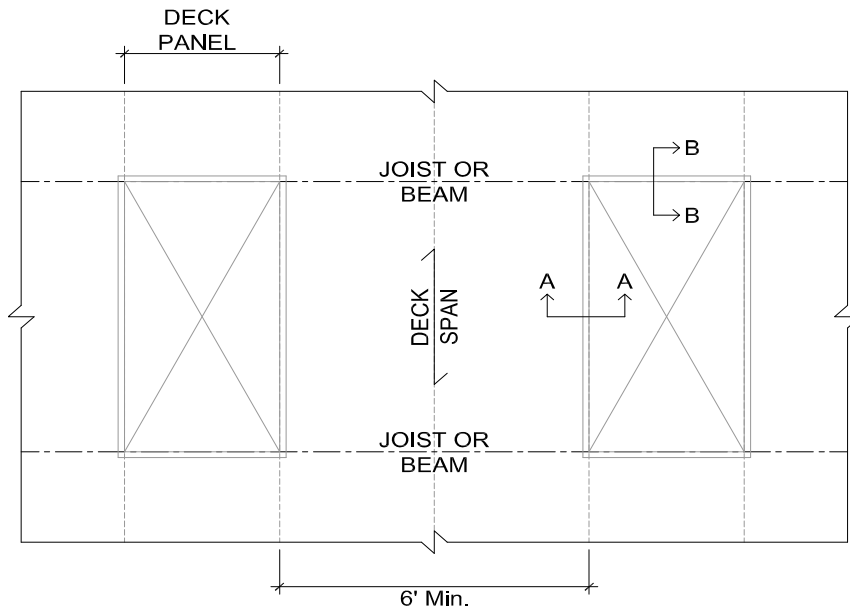

**A-A: Minimum Roof Curb Attachment**  
(Edge Parallel to Deck)

### Recommended Opening Layout

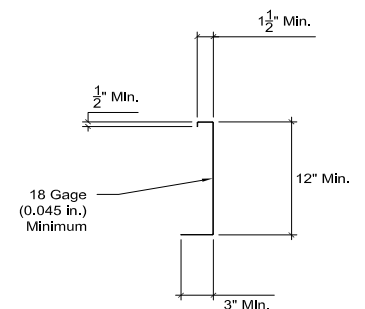

**Minimum Roof Curb Dimensions**

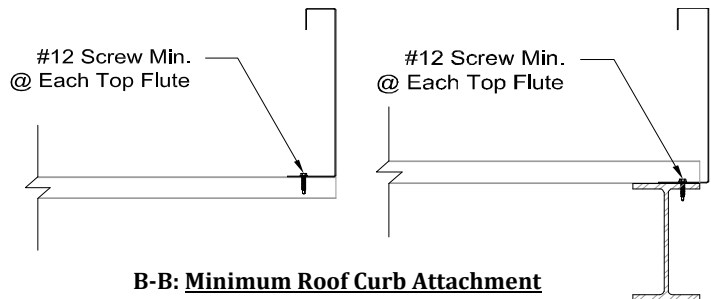

**B-B: Minimum Roof Curb Attachment**  
(Edge Perpendicular to Deck)



PLB-36 AND HSB-36 ROOF DECK SPANS FOR CONCENTRATED LOADS <sup>1-4</sup>				
Deck Gage	Number of Spans	Maximum Span based on Live Load Deflection		
		L / 360	L / 240	L / 180
22	1	7'-5"	9'-5"	11'-5"
	2	7'-10"	10'-11"	13'-0"
	3	7'-10"	10'-11"	12'-11"
20	1	8'-4"	11'-0"	13'-8"
	2	10'-0"	13'-8"	15'-11"
	3	10'-4"	≥ 14'-0"	≥ 14'-0"
18	1	9'-10"	12'-11"	15'-2"
	2	12'-1"	15'-10"	17'-4"
	3	12'-1"	≥ 14'-0"	≥ 14'-0"
16	1	11'-0"	15'-5"	18'-10"
	2	13'-10"	19'-6"	≥ 21'-0"
	3	14'-0"	≥ 14'-0"	≥ 14'-0"

<sup>1</sup> Deflection values based on a 300 lbs concentrated roof live load.

<sup>2</sup> Concentrated load distributed over a 2-1/2 ft x 2-1/2 ft per IBC section 1607.4.

<sup>3</sup> Concentrated load deflections based on an assembly that includes a minimum of 2 layers of 1-1/2" ASTM C 1289, Type II, Class 1, Grade 2 (20 psi) polyisocyanurate insulation board on the steel deck.

<sup>4</sup> Table is limited to the maximum available sheet length of 42'-0". For longer sheet lengths, please contact Verco Decking, Inc.

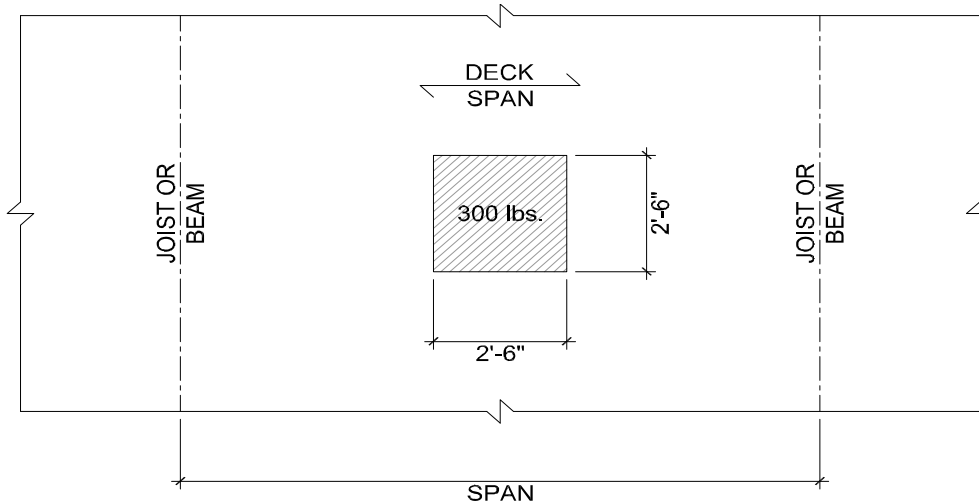

**Load Placement Bare Deck - Plan View**

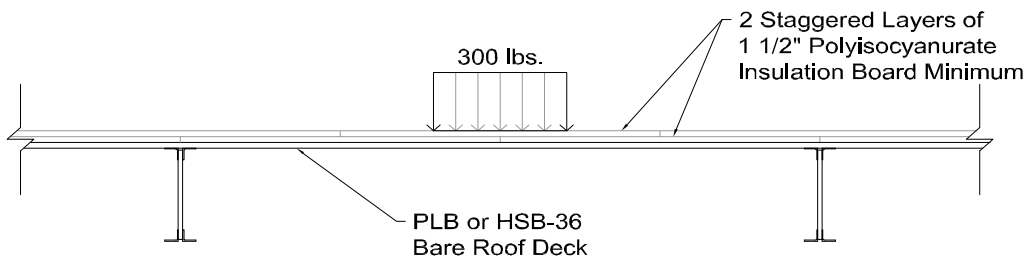

**Load Placement Bare Deck**



ITW BUILDEX SAMMYS X-PRESS CONNECTION <sup>1-10</sup>									
SAMMYS X-Press Type			Deck Gage	Solid Material (Gr. 50)			Perforated Material (Gr. 50)		
Part Number	Model Number <sup>2-4</sup>	Rod Size (in.)		ASD $P_{not}/\Omega$ (lbs)	LRFD $\phi P_{not}$ (lbs)	Max. Fire Sprinkler Pipe Size <sup>9</sup> (in.)	ASD $P_{not}/\Omega$ (lbs)	LRFD $\phi P_{not}$ (lbs)	Max. Fire Sprinkler Pipe Size <sup>9</sup> (in.)
8181922	XP 200	1/4	22	332	528	2 1/2	232	363	2
8150922	XP 20	3/8	20	399	634	2 1/2	278	436	2
8294922	SXP 20	3/8	19	467	742	3	326	511	2 1/2
8272957	SXP 2.0	1/2	18	531	844	3 1/2	371	581	2 1/2
8181922	XP 200	1/4	16	664	1056	4	464	727	3 1/2
8295922	XP 35	3/8							
8295922	SXP 35	3/8							
8271957	SXP 3.5	1/2							

<sup>1</sup> For Solid:  $P_{not} = 0.453 \cdot t \cdot F_u$        $\Omega = 2.65$  (ASD)       $\phi = 0.60$  (LRFD)

For Perforated:  $P_{not} = 0.340 \cdot t \cdot F_u$        $\Omega = 2.85$  (ASD)       $\phi = 0.55$  (LRFD)

Where  $P_{not}$  = Nominal pullout strength of SAMMYS X-Press Connector, kips

<sup>2</sup> XP 200 may not be used to support sprinkler pipe.

<sup>3</sup> XP 200, XP 20 and XP 35 shall be installed and loaded perpendicular to the deck surface.

<sup>4</sup> SXP 20, SXP 2.0, SXP 35 and SXP 3.5 may be installed in any flat portion of the bottom flange, web or top flange. The load may be applied at any angle,  $\theta$ , from 0 to 90 degrees,  $0^\circ \leq \theta \leq 90^\circ$ , relative to the axis of the base of the connector and any angle,  $\alpha$ , from 0 to 360 degrees,  $0^\circ \leq \alpha \leq 360^\circ$ , relative to the ribs of the steel deck as shown below.

<sup>5</sup> Deck may be web perforated or fully perforated FP11 (11% open area).

<sup>6</sup> SAMMYS X-Press shall not be installed in fully perforated FP21 (21% open area) deck.

<sup>7</sup> The allowable strength,  $P_n/\Omega$ , shall be equal to or greater than the governing nominal load or load combination for Allowable Stress Design (ASD) as stipulated in the IBC or ASCE/SEI 7.

<sup>8</sup> The factored strength,  $\phi P_n$ , shall be equal to or greater than the governing factored load or factored load combination for Load and Resistance Factor Design as stipulated in the IBC or ASCE/SEI 7.

<sup>9</sup> Maximum fire sprinkler pipe size in accordance with NFPA 13.

<sup>10</sup> SAMMYS X-Press shall be installed per manufacturers instructions.

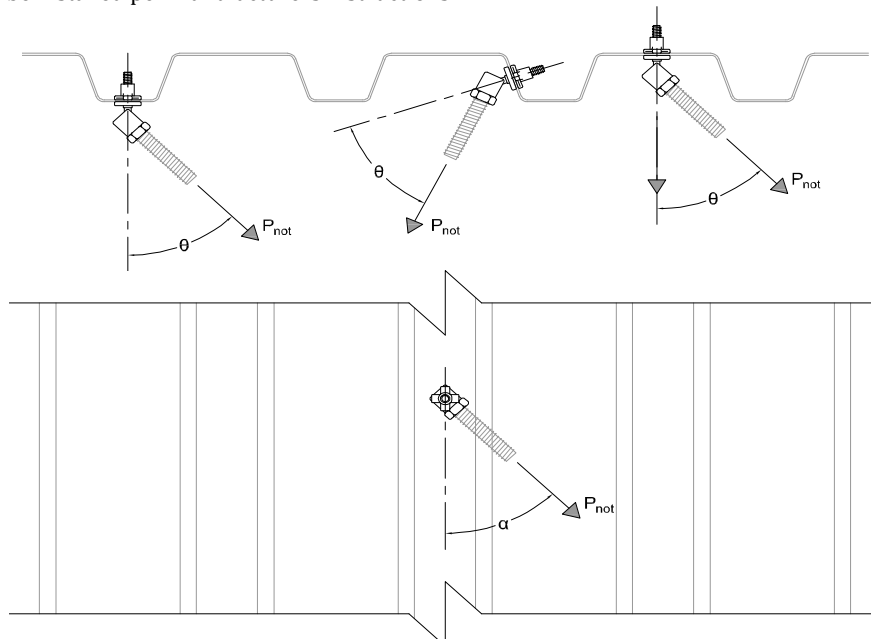

**Sammy X-Press Swivel Head<sup>®</sup> Connector**



## DEFINITION OF SYMBOLS

Symbol	Definition	Units
$A_g$	Gross area of cross-section	in <sup>2</sup> /ft
$A_{gbf}$	Gross area of bottom flange	in <sup>2</sup>
$A_{gtf}$	Gross area of top flange	in <sup>2</sup>
$A_n$	Net area of cross-section, $A_n=A_g$ for non-perforated profiles	in <sup>2</sup> /ft
$A_{sbf}$	Cross-sectional area of bottom flange stiffener	in <sup>2</sup>
$A_{stf}$	Cross-sectional area of top flange stiffener	in <sup>2</sup>
$b_{obf}$	Overall flat width of stiffened bottom flange	in.
$b_{otf}$	Overall flat width of stiffened top flange	in.
$b_{pbf}$	Largest sub-element flat of stiffened bottom flange	in.
$b_{ptf}$	Largest sub-element flat of stiffened top flange	in.
$c_p$	Center-to-center spacing of perforation holes	in.
$c_{sbf}$	Horizontal distance from edge of bottom flange to centerline of bottom flange stiffener	in.
$c_{stf}$	Horizontal distance from edge of top flange to centerline of top flange stiffener	in.
$d_p$	Diameter of perforation hole	in.
$E$	Modulus of elasticity of steel = 29,500	ksi
$E_p$	Width of perforated band in bottom flange	in.
$F_p$	Width of perforated band in top flange	in.
$F_u$	Tensile strength of steel	ksi
$F_y$	Yield strength of steel	ksi
$G$	Shear modulus of steel = 11,300	ksi
$h_w$	Flat dimension of web measured in plane of web	in.
$I_{d+}$	Positive moment of inertia for deflection due to vertical uniform loads, $I_{d+}=(2I_{e+}+I_x)/3$	in <sup>4</sup> /ft
$I_{d-}$	Negative moment of inertia for deflection due to vertical uniform loads, $I_{d-}=(2I_{e-}+I_x)/3$	in <sup>4</sup> /ft
$I_{e+}$	Positive effective moment of inertia	in <sup>4</sup> /ft
$I_{e-}$	Negative effective moment of inertia	in <sup>4</sup> /ft
$I_{spbf}$	Moment of inertia of stiffener about centerline of flat portion of bottom flange	in <sup>4</sup>
$I_{sptf}$	Moment of inertia of stiffener about centerline of flat portion of top flange	in <sup>4</sup>
$I_{xg}$	Moment of inertia of gross section (considering perforations for acoustic panels)	in <sup>4</sup> /ft
$K$	Composite deck-slab coefficient	-
$M_{n+}$	Nominal positive flexural strength of deck or panel, $M_{n+}=F_y \cdot S_{e+}$	k-ft/ft
$M_{n-}$	Nominal negative flexural strength of deck or panel, $M_{n-}=F_y \cdot S_{e-}$	k-ft/ft
$M_{nxt+}$	Nominal positive flexural strength with respect to centroidal axes considering tension yielding, $M_{nxt+}=F_y \cdot S_{ft+}$	k-ft/ft
$M_{nxt-}$	Nominal negative flexural strength with respect to centroidal axes considering tension yielding, $M_{nxt-}=F_y \cdot S_{ft-}$	k-ft/ft
$P_p$	Width of perforated band in bottom pan of cellular deck	in.
$R$	Inside bend radius	in.
$r$	Radius of gyration of gross section, $r=(I_{xg}/A_g)^{0.5}$	in.



### DEFINITION OF SYMBOLS

Symbol	Definition	Units
$S_{bp}$	Spacing of resistance spot welds fastening panel to bottom pan for cellular deck	in.
$S_{e+}$	Positive effective section modulus	in <sup>3</sup> /ft
$S_{e-}$	Negative effective section modulus	in <sup>3</sup> /ft
$S_{xb}$	Section modulus about the X axis for the extreme top fiber of gross section, $S_{xb}=I_{xg}/y_b$	in <sup>3</sup> /ft
$S_{xt}$	Section modulus about the X axis for the extreme bottom fiber of gross section, $S_{xt}=I_{xg}/y_t$	in <sup>3</sup> /ft
$T_n$	Nominal tensile axial strength of panel, $T_n=F_y \cdot A_n$	k/ft
$t$	Base steel thickness of panel	in.
$t_b$	Base steel thickness of bottom element in cellular deck	in.
$V_n$	Nominal vertical web shear strength of panel	k/ft
$V_{ni}$	Nominal vertical shear capacity based on resistance weld strength (inverted deck orientation)	k/ft
$V_{nn}$	Nominal vertical shear capacity based on resistance weld strength (normal deck orientation)	k/ft
$W_p$	Width of perforated band in web	in.
$w_{bf}$	Flat width of bottom flange	in.
$w_{bp}$	Flat width of bottom pan between resistance welds	in.
$w_{ad}$	Weight of deck	psf
$w_{tf}$	Flat width of top flange	in.
$y_b$	Distance from extreme bottom fiber to neutral axis of gross section	in.
$y_t$	Distance from extreme top fiber to neutral axis of gross section	in.
$\theta$	Angle between plane of web and plane of bearing surface	deg.





### DEFINITION OF SYMBOLS FOR DIRECT STRENGTH METHOD

Symbol	Definition	Units
$A_g$	Gross area of cross-section	in <sup>2</sup>
$C_w$	Torsional warping constant of cross-section	in <sup>6</sup>
$I_{xg}$	Moment of inertia of gross section about x-axis	in <sup>4</sup>
$I_{yg}$	Moment of inertia of gross section about y-axis	in <sup>4</sup>
$J$	St. Venant torsion constant of cross-section	in <sup>4</sup>
$j_x$	Asymmetry property for lateral-torsional buckling	in.
$M_{crdx+}$	Elastic Distortional Buckling Moment (+X)	k-in
$M_{crdx-}$	Elastic Distortional Buckling Moment (-X)	k-in
$M_{crdy+}$	Elastic Distortional Buckling Moment (+Y)	k-in
$M_{crdy-}$	Elastic Distortional Buckling Moment (-Y)	k-in
$M_{crlx+}$	Elastic Local Buckling Moment (+X)	k-in
$M_{crlx-}$	Elastic Local Buckling Moment (-X)	k-in
$M_{crlly+}$	Elastic Local Buckling Moment (+Y)	k-in
$M_{crlly-}$	Elastic Local Buckling Moment (-Y)	k-in
$P_{crd}$	Elastic Distortional Buckling Compression Force	k
$P_{crl}$	Elastic Local Buckling Compression Force	k
$r_x$	Radius of gyration of gross section about x-axis	in.
$r_y$	Radius of gyration of gross section about y-axis	in.
$r_0$	Polar radius of gyration about shear center	in.
$S_{xb}$	Section modulus about the X axis for the extreme top fiber of gross section, $S_{xb}=I_{xg}/y_b$	in <sup>3</sup>
$S_{xt}$	Section modulus about the X axis for the extreme bottom fiber of gross section, $S_{xt}=I_{xg}/y_t$	in <sup>3</sup>
$S_{yl}$	Section modulus about the Y axis for the extreme left fiber of gross section, $S_{yl}=I_{yg}/x_l$	in <sup>3</sup>
$S_{yr}$	Section modulus about the Y axis for the extreme right fiber of gross section, $S_{yr}=I_{yg}/x_r$	in <sup>3</sup>
$x_0$	Distance from centroid to shear center in principal x-axis direction	in.
$y_0$	Distance from centroid to shear center in principal y-axis direction	in.



Non-Embossed Profiles

PLB-36, HSB-36, HSB-36-SS  
HSB-30-NS

Embossed Profiles

PLB-36 FormLok,  
B-36 FormLok,  
B-36-SS FormLok

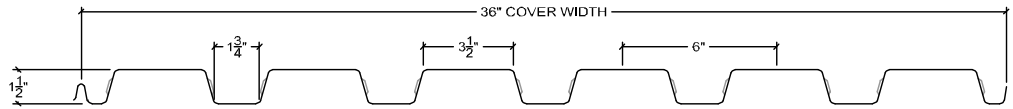

Gage	t in.	w <sub>dd</sub> psf	A <sub>g</sub> in <sup>2</sup> /ft	I <sub>xg</sub> in <sup>4</sup> /ft	S <sub>xb</sub> in <sup>3</sup> /ft	S <sub>xt</sub> in <sup>3</sup> /ft	y <sub>b</sub> in.	y <sub>t</sub> in.	r in.	h <sub>w</sub> in.	θ deg.	K <sub>min</sub> -
22	0.0299	1.9	0.506	0.193	0.211	0.313	0.913	0.617	0.618	1.240	75.1	1.000
20	0.0359	2.3	0.607	0.231	0.252	0.373	0.916	0.620	0.617	1.238	75.0	1.000
18	0.0478	2.9	0.807	0.306	0.332	0.490	0.923	0.625	0.616	1.233	74.7	1.000
16	0.0598	3.5	1.007	0.381	0.410	0.605	0.929	0.630	0.615	1.228	74.3	1.000

GRADE 50: F <sub>y</sub> = 50 ksi, F <sub>u</sub> = 65 ksi												
Gage	I <sub>e+</sub> in <sup>4</sup> /ft	I <sub>e-</sub> in <sup>4</sup> /ft	I <sub>d+</sub> in <sup>4</sup> /ft	I <sub>d-</sub> in <sup>4</sup> /ft	S <sub>e+</sub> in <sup>3</sup> /ft	S <sub>e-</sub> in <sup>3</sup> /ft	M <sub>n+</sub> k-ft/ft	M <sub>n-</sub> k-ft/ft	M <sub>nxt+</sub> k-ft/ft	M <sub>nxt-</sub> k-ft/ft	V <sub>n</sub> k/ft	T <sub>n</sub> k/ft
22	0.170	0.192	0.178	0.192	0.176	0.188	0.733	0.783	0.879	1.304	4.300	25.30
20	0.213	0.231	0.219	0.231	0.230	0.237	0.958	0.988	1.050	1.554	5.152	30.35
18	0.300	0.306	0.302	0.306	0.314	0.331	1.308	1.379	1.383	2.042	6.822	40.35
16	0.381	0.381	0.381	0.381	0.399	0.410	1.663	1.708	1.708	2.521	8.483	50.35

R	w <sub>tf</sub>	w <sub>bf</sub>
in.	in.	in.
0.188	3.125	1.375



Non-Embossed Profiles

PLB-36, HSB-36, HSB-36-SS

Embossed Profiles

PLB-36 FormLok,

B-36 FormLok,

B-36-SS FormLok

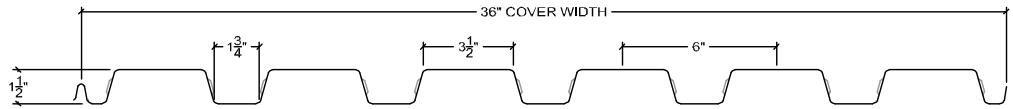

**GRADE 50**

Gage	$A_g$ in <sup>2</sup>	$x_0$ in.	$y_0$ in.	$r_0$ in.	$j_x$ in.	$C_w$ in <sup>6</sup>	$J$ in <sup>4</sup>	$P_{crl}$ k	$P_{crd}$ k
22	1.5184	0.244	0.195	10.829	-0.208	67.793	0.000453	26.439	9.158
20	1.8212	0.248	0.193	10.828	-0.212	81.271	0.000782	43.621	24.692
18	2.4198	0.255	0.193	10.827	-0.219	107.610	0.001843	96.212	48.712
16	3.0191	0.260	0.192	10.816	-0.225	133.590	0.003599	181.950	87.350

Gage	$I_{xg}$ in <sup>4</sup>	$S_{xt}$ in <sup>3</sup>	$S_{xb}$ in <sup>3</sup>	$r_x$ in.	$M_{crlx+}$ k-in	$M_{crdx+}$ k-in	$M_{crlx-}$ k-in	$M_{crdx-}$ k-in
22	0.58	0.937	0.633	0.617	17.11	69.56	52.11	93.07
20	0.69	1.116	0.757	0.617	28.19	123.02	86.64	114.50
18	0.92	1.469	0.995	0.616	62.28	182.03	187.63	226.67
16	1.14	1.814	1.229	0.615	117.80	328.20	345.80	289.00

Gage	$I_{yg}$ in <sup>4</sup>	$S_{yl}$ in <sup>3</sup>	$S_{yr}$ in <sup>3</sup>	$r_y$ in.	$M_{crlx+}$ k-in	$M_{crdy+}$ k-in	$M_{crlx-}$ k-in	$M_{crdy-}$ k-in
22	177.33	9.858	9.691	10.807	205.32	80.57	211.19	221.12
20	212.65	11.818	11.618	10.806	337.88	146.38	347.66	178.19
18	282.49	15.692	15.427	10.805	744.10	201.28	766.07	573.06
16	351.76	19.546	19.219	10.794	1403.60	398.20	1445.90	2102.90



Non-Embossed Profiles  
**HSBR-30-NS, HSBR-36,**  
**HSBR-36-SS**

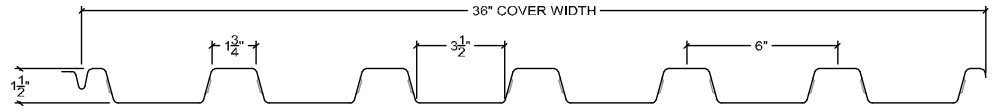

Embossed Profiles  
**BR-36 FormLok,**  
**BR-36-SS FormLok**

Gage	t in.	w <sub>dd</sub> psf	A <sub>g</sub> in <sup>2</sup> /ft	I <sub>xg</sub> in <sup>4</sup> /ft	S <sub>xb</sub> in <sup>3</sup> /ft	S <sub>xt</sub> in <sup>3</sup> /ft	y <sub>b</sub> in.	y <sub>t</sub> in.	r in.	h <sub>w</sub> in.	θ deg.	K <sub>min</sub> -
22	0.0299	1.9	0.506	0.193	0.313	0.211	0.617	0.913	0.618	1.240	75.1	1.000
20	0.0359	2.3	0.607	0.231	0.373	0.252	0.620	0.916	0.617	1.238	75.0	1.000
18	0.0478	2.9	0.807	0.306	0.490	0.332	0.625	0.923	0.616	1.233	74.7	1.000
16	0.0598	3.5	1.007	0.381	0.605	0.410	0.630	0.929	0.615	1.228	74.3	1.000

GRADE 50: F <sub>y</sub> = 50 ksi, F <sub>u</sub> = 65 ksi												
Gage	I <sub>e+</sub> in <sup>4</sup> /ft	I <sub>e-</sub> in <sup>4</sup> /ft	I <sub>d+</sub> in <sup>4</sup> /ft	I <sub>d-</sub> in <sup>4</sup> /ft	S <sub>e+</sub> in <sup>3</sup> /ft	S <sub>e-</sub> in <sup>3</sup> /ft	M <sub>n+</sub> k-ft/ft	M <sub>n-</sub> k-ft/ft	M <sub>nxt+</sub> k-ft/ft	M <sub>nxt-</sub> k-ft/ft	V <sub>n</sub> k/ft	T <sub>n</sub> k/ft
22	0.192	0.170	0.192	0.178	0.188	0.176	0.783	0.733	1.304	0.879	4.300	25.30
20	0.231	0.213	0.231	0.219	0.237	0.230	0.988	0.958	1.554	1.050	5.152	30.35
18	0.306	0.300	0.306	0.302	0.331	0.314	1.379	1.308	2.042	1.383	6.822	40.35
16	0.381	0.381	0.381	0.381	0.410	0.399	1.708	1.663	2.521	1.708	8.483	50.35

R	w <sub>tf</sub>	w <sub>bf</sub>
in.	in.	in.
0.188	1.375	3.125



Non-Embossed Profiles

PLN3-32, HSN3-32,  
HSN3-32-SS, HSN3-32-NS

Embossed Profiles

PLN3-32 FormLok,  
N3-32 FormLok,  
N3-32-SS FormLok,  
N3-32-NS FormLok

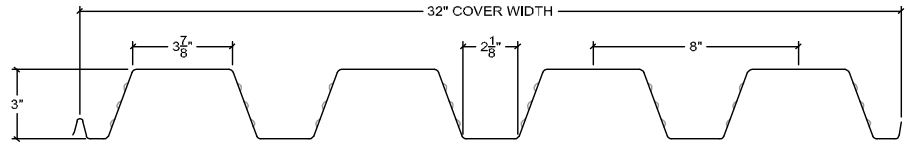

Gage	t in.	w <sub>dd</sub> psf	A <sub>g</sub> in <sup>2</sup> /ft	I <sub>xg</sub> in <sup>4</sup> /ft	S <sub>xb</sub> in <sup>3</sup> /ft	S <sub>xt</sub> in <sup>3</sup> /ft	y <sub>b</sub> in.	y <sub>t</sub> in.	r in.	h <sub>w</sub> in.	θ deg.	K <sub>min</sub> -
22	0.0299	2.0	0.567	0.800	0.474	0.596	1.687	1.343	1.188	2.879	71.2	1.000
20	0.0359	2.4	0.680	0.959	0.567	0.712	1.690	1.346	1.188	2.877	71.1	1.000
18	0.0478	3.1	0.905	1.273	0.750	0.942	1.697	1.351	1.186	2.872	71.0	1.000
16	0.0598	3.9	1.130	1.587	0.932	1.169	1.703	1.357	1.185	2.867	70.8	1.000

GRADE 50: F <sub>y</sub> = 50 ksi, F <sub>u</sub> = 65 ksi												
Gage	I <sub>e+</sub> in <sup>4</sup> /ft	I <sub>e-</sub> in <sup>4</sup> /ft	I <sub>d+</sub> in <sup>4</sup> /ft	I <sub>d-</sub> in <sup>4</sup> /ft	S <sub>e+</sub> in <sup>3</sup> /ft	S <sub>e-</sub> in <sup>3</sup> /ft	M <sub>n+</sub> k-ft/ft	M <sub>n-</sub> k-ft/ft	M <sub>nxt+</sub> k-ft/ft	M <sub>nxt-</sub> k-ft/ft	V <sub>n</sub> k/ft	T <sub>n</sub> k/ft
22	0.681	0.778	0.721	0.785	0.353	0.405	1.471	1.688	1.975	2.483	3.754	28.35
20	0.855	0.950	0.890	0.953	0.452	0.509	1.883	2.121	2.363	2.967	6.127	34.00
18	1.207	1.273	1.229	1.273	0.671	0.722	2.796	3.008	3.125	3.925	10.917	45.25
16	1.562	1.587	1.570	1.587	0.883	0.932	3.679	3.883	3.883	4.871	14.572	56.50

R	w <sub>tf</sub>	w <sub>bf</sub>
in.	in.	in.
0.188	3.523	1.773



Non-Embossed Profiles

PLN3-32, HSN3-32,  
HSN3-32-SS

Embossed Profiles

PLN3-32 FormLok,  
N3-32 FormLok,  
N3-32-SS FormLok

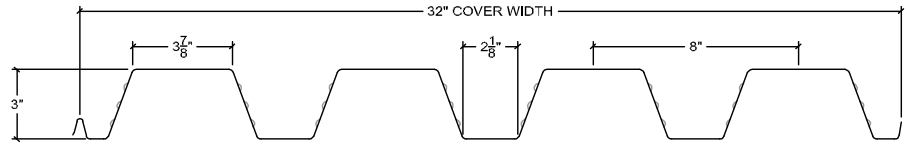

**GRADE 50**

Gage	A <sub>g</sub> in <sup>2</sup>	x <sub>0</sub> in.	y <sub>0</sub> in.	r <sub>0</sub> in.	j <sub>x</sub> in.	C <sub>w</sub> in <sup>6</sup>	J in <sup>4</sup>	P <sub>cr1</sub> k	P <sub>crd</sub> k
22	1.5120	0.150	0.521	9.691	-0.108	217.230	0.000451	13.842	20.445
20	1.8141	0.152	0.520	9.690	-0.110	260.370	0.000779	23.342	29.655
18	2.4120	0.156	0.518	9.688	-0.114	345.500	0.001837	53.518	52.492
16	3.0132	0.160	0.516	9.686	-0.119	430.750	0.003592	103.240	82.830

Gage	I <sub>xg</sub> in <sup>4</sup>	S <sub>xt</sub> in <sup>3</sup>	S <sub>xb</sub> in <sup>3</sup>	r <sub>x</sub> in.	M <sub>cr1x+</sub> k-in	M <sub>crdx+</sub> k-in	M <sub>cr1x-</sub> k-in	M <sub>crdx-</sub> k-in
22	2.13	1.587	1.264	1.188	15.42	324.51	57.15	29.54
20	2.56	1.899	1.513	1.187	26.22	413.69	91.69	43.11
18	3.39	2.512	2.001	1.186	60.70	853.16	197.12	74.63
16	4.23	3.121	2.486	1.185	117.70	1150.20	365.30	117.90

Gage	I <sub>yg</sub> in <sup>4</sup>	S <sub>yl</sub> in <sup>3</sup>	S <sub>yr</sub> in <sup>3</sup>	r <sub>y</sub> in.	M <sub>crly+</sub> k-in	M <sub>crdy+</sub> k-in	M <sub>crly-</sub> k-in	M <sub>crdy-</sub> k-in
22	139.42	8.744	8.542	9.603	106.53	135.63	108.06	127.44
20	167.25	10.486	10.245	9.602	179.61	197.20	182.28	182.32
18	222.28	13.929	13.611	9.600	411.34	345.78	417.84	327.20
16	277.58	17.384	16.991	9.598	792.50	547.10	804.80	514.80



Non-Embossed Profiles

PLN-24, N-24, N-24-SS

Embossed Profiles

PLN-24 FormLok,

N-24 FormLok,

N-24-SS FormLok

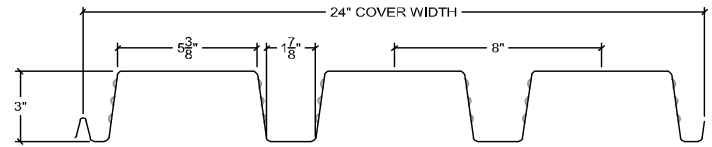

Gage	t in.	w <sub>dd</sub> psf	A <sub>g</sub> in <sup>2</sup> /ft	I <sub>xg</sub> in <sup>4</sup> /ft	S <sub>xb</sub> in <sup>3</sup> /ft	S <sub>xt</sub> in <sup>3</sup> /ft	y <sub>b</sub> in.	y <sub>t</sub> in.	r in.	h <sub>w</sub> in.	θ deg.	K <sub>min</sub> -
22	0.0299	2.2	0.617	0.862	0.466	0.730	1.849	1.181	1.182	2.672	82.4	1.000
20	0.0359	2.6	0.740	1.032	0.557	0.872	1.852	1.184	1.181	2.668	82.3	1.000
18	0.0478	3.5	0.983	1.369	0.736	1.152	1.860	1.188	1.180	2.661	82.1	1.000
16	0.0598	4.2	1.227	1.706	0.914	1.430	1.867	1.193	1.179	2.653	81.9	0.994

GRADE 50: F <sub>y</sub> = 50 ksi, F <sub>u</sub> = 65 ksi												
Gage	I <sub>e+</sub>	I <sub>e-</sub>	I <sub>d+</sub>	I <sub>d-</sub>	S <sub>e+</sub>	S <sub>e-</sub>	M <sub>n+</sub>	M <sub>n-</sub>	M <sub>nxt+</sub>	M <sub>nxt-</sub>	V <sub>n</sub>	T <sub>n</sub>
	I <sub>xg</sub>		S <sub>xt</sub>	S <sub>xb</sub>			r <sub>x</sub>	M <sub>crlx+</sub>	M <sub>crdx+</sub>	M <sub>crlx-</sub>		M <sub>crdx-</sub>
22	0.668	0.854	0.733	0.857	0.344	0.429	1.433	1.788	1.942	3.042	4.236	30.85
20	0.845	1.031	0.907	1.031	0.443	0.531	1.846	2.213	2.321	3.633	6.418	37.00
18	1.216	1.369	1.267	1.369	0.652	0.735	2.717	3.063	3.067	4.800	11.339	49.15
16	1.610	1.706	1.642	1.706	0.837	0.914	3.488	3.808	3.808	5.958	14.136	61.35

R	w <sub>tf</sub>	w <sub>bf</sub>
in.	in.	in.
0.188	4.946	1.446





Non-Embossed Profiles

PLN-24, N-24, N-24-SS

Embossed Profiles

PLN-24 FormLok,

N-24 FormLok,

N-24-SS FormLok

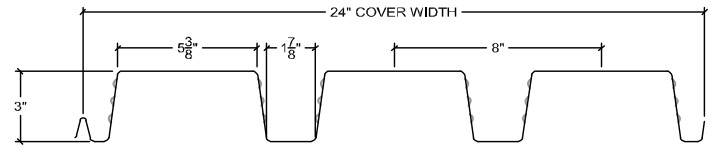

**GRADE 50**

Gage	$A_g$ in <sup>2</sup>	$x_0$ in.	$y_0$ in.	$r_0$ in.	$j_x$ in.	$C_w$ in <sup>6</sup>	$J$ in <sup>4</sup>	$P_{crl}$ k	$P_{crd}$ k
22	1.2334	0.152	0.978	7.523	-0.080	107.490	0.000368	5.925	18.015
20	1.4793	0.154	0.976	7.522	-0.081	128.770	0.000636	10.169	67.558
18	1.9657	0.157	0.973	7.519	-0.085	170.680	0.001497	23.801	46.279
16	2.4541	0.161	0.970	7.517	-0.088	212.560	0.002925	46.430	181.430

Gage	$I_{xg}$ in <sup>4</sup>	$S_{xt}$ in <sup>3</sup>	$S_{xb}$ in <sup>3</sup>	$r_x$ in.	$M_{crlx+}$ k-in	$M_{crdx+}$ k-in	$M_{crlx-}$ k-in	$M_{crdx-}$ k-in
22	1.72	1.459	0.932	1.182	7.00	466.09	42.77	24.42
20	2.07	1.745	1.115	1.181	12.04	557.40	70.06	35.33
18	2.74	2.305	1.473	1.180	28.22	544.03	154.85	62.78
16	3.41	2.860	1.828	1.179	55.09	748.29	292.19	98.50

Gage	$I_{yg}$ in <sup>4</sup>	$S_{yt}$ in <sup>3</sup>	$S_{yb}$ in <sup>3</sup>	$r_y$ in.	$M_{crlx+}$ k-in	$M_{crdy+}$ k-in	$M_{crlx-}$ k-in	$M_{crdy-}$ k-in
22	66.87	5.623	5.432	7.363	39.69	98.33	40.30	89.42
20	80.18	6.740	6.512	7.362	68.12	141.50	69.20	128.31
18	106.49	8.943	8.644	7.360	159.34	252.61	161.95	229.71
16	132.88	11.150	10.780	7.358	310.54	396.64	315.79	551.82



Embossed Profiles

PLW2-36 FormLok,  
W2-36 FormLok,  
W2-36-SS FormLok

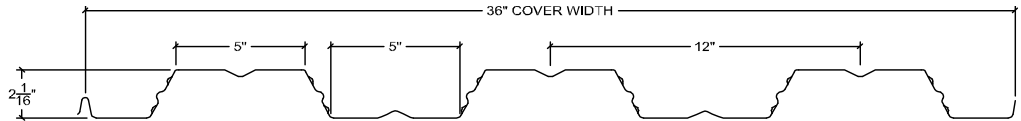

Gage	t in.	w <sub>dd</sub> psf	A <sub>g</sub> in <sup>2</sup> /ft	I <sub>xg</sub> in <sup>4</sup> /ft	S <sub>xb</sub> in <sup>3</sup> /ft	S <sub>xt</sub> in <sup>3</sup> /ft	y <sub>b</sub> in.	y <sub>t</sub> in.	r in.	h <sub>w</sub> in.	θ deg.	K <sub>min</sub> -
22	0.0300	1.8	0.464	0.362	0.353	0.339	1.026	1.067	0.883	2.049	63.7	1.000
21	0.0330	2.0	0.511	0.398	0.388	0.373	1.027	1.068	0.883	2.048	63.7	1.000
20	0.0360	2.1	0.557	0.434	0.422	0.406	1.029	1.070	0.883	2.047	63.6	1.000
19	0.0420	2.4	0.650	0.506	0.490	0.472	1.032	1.073	0.882	2.045	63.6	1.000
18	0.0470	2.7	0.727	0.565	0.546	0.526	1.035	1.075	0.882	2.044	63.5	1.000
16	0.0590	3.3	0.912	0.709	0.681	0.656	1.041	1.081	0.882	2.041	63.3	0.854

GRADE 50: F <sub>y</sub> = 50 ksi, F <sub>u</sub> = 65 ksi												
Gage	I <sub>e+</sub> in <sup>4</sup> /ft	I <sub>e-</sub> in <sup>4</sup> /ft	I <sub>d+</sub> in <sup>4</sup> /ft	I <sub>d-</sub> in <sup>4</sup> /ft	S <sub>e+</sub> in <sup>3</sup> /ft	S <sub>e-</sub> in <sup>3</sup> /ft	M <sub>n+</sub> k-ft/ft	M <sub>n-</sub> k-ft/ft	M <sub>nxt+</sub> k-ft/ft	M <sub>nxt-</sub> k-ft/ft	V <sub>n</sub> k/ft	T <sub>n</sub> k/ft
22	0.330	0.327	0.341	0.339	0.246	0.256	1.025	1.067	1.471	1.413	2.718	23.20
21	0.372	0.369	0.381	0.379	0.283	0.294	1.179	1.225	1.617	1.554	3.289	25.55
20	0.416	0.412	0.422	0.419	0.323	0.333	1.346	1.388	1.758	1.692	3.911	27.85
19	0.502	0.496	0.503	0.499	0.405	0.415	1.688	1.729	2.042	1.967	4.616	32.50
18	0.564	0.560	0.564	0.562	0.471	0.481	1.963	2.004	2.275	2.192	5.158	36.35
16	0.707	0.707	0.708	0.708	0.623	0.638	2.596	2.658	2.838	2.733	6.455	45.60

Gage	A <sub>gtf</sub> in <sup>2</sup>	A <sub>stf</sub> in <sup>2</sup>	I <sub>sptf</sub> in <sup>4</sup>	A <sub>gbf</sub> in <sup>2</sup>	A <sub>sbf</sub> in <sup>2</sup>	I <sub>spbf</sub> in <sup>4</sup>
22	0.148	0.036	0.001	0.148	0.036	0.001
21	0.163	0.040	0.001	0.163	0.040	0.001
20	0.177	0.043	0.001	0.177	0.043	0.001
19	0.206	0.050	0.002	0.206	0.050	0.002
18	0.231	0.056	0.002	0.231	0.056	0.002
16	0.289	0.071	0.002	0.289	0.071	0.002

b <sub>otf</sub> in.	b <sub>ptf</sub> in.	c <sub>stf</sub> in.	b <sub>obf</sub> in.	b <sub>pbf</sub> in.	c <sub>sbf</sub> in.
4.696	1.848	2.348	4.696	1.848	2.348

R in.	w <sub>tf</sub> in.	w <sub>bf</sub> in.
0.188	4.696	4.696



Embossed Profiles

PLW3-36 FormLok,  
W3-36 FormLok,  
W3-36-SS FormLok

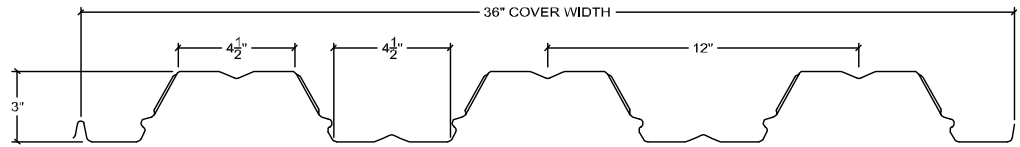

Gage	t in.	w <sub>dd</sub> psf	A <sub>g</sub> in <sup>2</sup> /ft	I <sub>xg</sub> in <sup>4</sup> /ft	S <sub>xb</sub> in <sup>3</sup> /ft	S <sub>xt</sub> in <sup>3</sup> /ft	y <sub>b</sub> in.	y <sub>t</sub> in.	r in.	h <sub>w</sub> in.	θ deg.	K <sub>min</sub> -
22	0.0299	1.9	0.497	0.761	0.515	0.490	1.478	1.552	1.237	3.113	63.2	0.000
21	0.0330	2.1	0.548	0.840	0.568	0.541	1.480	1.553	1.238	3.113	63.1	0.000
20	0.0359	2.3	0.596	0.914	0.617	0.588	1.481	1.555	1.238	3.112	63.1	0.000
19	0.0420	2.7	0.697	1.068	0.719	0.685	1.485	1.558	1.238	3.110	63.0	0.000
18	0.0478	2.9	0.793	1.214	0.816	0.778	1.488	1.560	1.237	3.108	63.0	0.000
16	0.0598	3.5	0.991	1.517	1.015	0.969	1.494	1.566	1.237	3.105	62.9	0.000

GRADE 50: F <sub>y</sub> = 50 ksi, F <sub>u</sub> = 65 ksi												
Gage	I <sub>e+</sub> in <sup>4</sup> /ft	I <sub>e-</sub> in <sup>4</sup> /ft	I <sub>d+</sub> in <sup>4</sup> /ft	I <sub>d-</sub> in <sup>4</sup> /ft	S <sub>e+</sub> in <sup>3</sup> /ft	S <sub>e-</sub> in <sup>3</sup> /ft	M <sub>n+</sub> k-ft/ft	M <sub>n-</sub> k-ft/ft	M <sub>nxt+</sub> k-ft/ft	M <sub>nxt-</sub> k-ft/ft	V <sub>n</sub> k/ft	T <sub>n</sub> k/ft
22	0.723	0.715	0.736	0.730	0.393	0.410	1.638	1.708	2.146	2.042	2.183	24.85
21	0.816	0.806	0.824	0.817	0.453	0.470	1.888	1.958	2.367	2.254	2.932	27.40
20	0.904	0.892	0.907	0.899	0.510	0.528	2.125	2.200	2.571	2.450	3.776	29.80
19	1.067	1.058	1.067	1.061	0.636	0.652	2.650	2.717	2.996	2.854	5.295	34.85
18	1.213	1.210	1.213	1.211	0.752	0.768	3.133	3.200	3.400	3.242	6.858	39.65
16	1.515	1.516	1.516	1.516	0.968	0.966	4.033	4.025	4.229	4.038	9.918	49.55

Gage	A <sub>gtf</sub> in <sup>2</sup>	A <sub>stf</sub> in <sup>2</sup>	I <sub>sptf</sub> in <sup>4</sup>	A <sub>gbf</sub> in <sup>2</sup>	A <sub>sbf</sub> in <sup>2</sup>	I <sub>spbf</sub> in <sup>4</sup>
22	0.132	0.036	0.001	0.132	0.036	0.001
21	0.146	0.040	0.001	0.146	0.040	0.001
20	0.159	0.043	0.001	0.159	0.043	0.001
19	0.186	0.050	0.002	0.186	0.050	0.002
18	0.211	0.057	0.002	0.211	0.057	0.002
16	0.263	0.072	0.002	0.263	0.072	0.002

b <sub>otf</sub> in.	b <sub>ptf</sub> in.	c <sub>stf</sub> in.	b <sub>obf</sub> in.	b <sub>pbf</sub> in.	c <sub>sbf</sub> in.
4.198	1.599	2.099	4.198	1.599	2.099

R in.	w <sub>tf</sub> in.	w <sub>bf</sub> in.
0.188	4.198	4.198



Non-Embossed Profiles

9/16 Shallow Vercor

9/16 Shallow Vercor Inverted

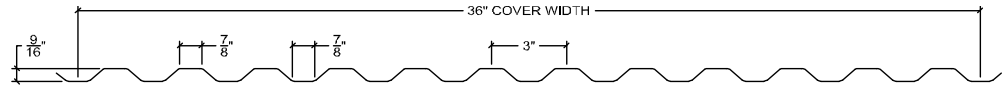

Gage	t in.	w <sub>dd</sub> psf	A <sub>g</sub> in <sup>2</sup> /ft	I <sub>xg</sub> in <sup>4</sup> /ft	S <sub>xb</sub> in <sup>3</sup> /ft	S <sub>xt</sub> in <sup>3</sup> /ft	y <sub>b</sub> in.	y <sub>t</sub> in.	r in.	h <sub>w</sub> in.	θ deg.
26	0.0179	1.0	0.256	0.013	0.046	0.044	0.283	0.298	0.225	0.696	41.7
24	0.0239	1.3	0.342	0.018	0.063	0.060	0.286	0.301	0.229	0.696	41.6
22	0.0299	1.6	0.428	0.022	0.076	0.072	0.289	0.304	0.227	0.696	41.5
20	0.0359	1.9	0.513	0.027	0.092	0.088	0.292	0.307	0.229	0.696	41.4

GRADE 80: F <sub>y</sub> = 60 ksi, F <sub>u</sub> = 62 ksi												
Gage	I <sub>e+</sub> in <sup>4</sup> /ft	I <sub>e-</sub> in <sup>4</sup> /ft	I <sub>d+</sub> in <sup>4</sup> /ft	I <sub>d-</sub> in <sup>4</sup> /ft	S <sub>e+</sub> in <sup>3</sup> /ft	S <sub>e-</sub> in <sup>3</sup> /ft	M <sub>n+</sub> k-ft/ft	M <sub>n-</sub> k-ft/ft	M <sub>nxt+</sub> k-ft/ft	M <sub>nxt-</sub> k-ft/ft	V <sub>n</sub> k/ft	T <sub>n</sub> k/ft
26	0.013	0.013	0.013	0.013	0.041	0.043	0.205	0.215	0.230	0.220	2.387	15.36
24	0.018	0.018	0.018	0.018	0.059	0.059	0.295	0.295	0.315	0.300	3.181	20.52
22	0.022	0.022	0.022	0.022	0.073	0.073	0.365	0.365	0.380	0.360	3.971	25.68
20	0.027	0.027	0.027	0.027	0.087	0.087	0.435	0.435	0.460	0.440	4.759	30.78

R in.	w <sub>tf</sub> in.	w <sub>bf</sub> in.
0.188	0.710	0.710



Non-Embossed Profiles

1-5/16 Deep Vercor

1-5/16 Deep Vercor Inverted

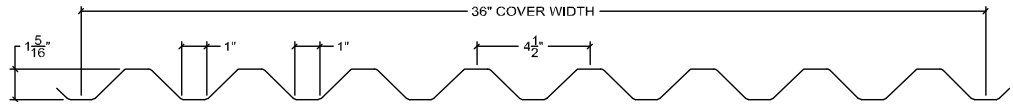

Gage	t in.	w <sub>dd</sub> psf	A <sub>g</sub> in <sup>2</sup> /ft	I <sub>xg</sub> in <sup>4</sup> /ft	S <sub>xb</sub> in <sup>3</sup> /ft	S <sub>xt</sub> in <sup>3</sup> /ft	y <sub>b</sub> in.	y <sub>t</sub> in.	r in.	h <sub>w</sub> in.	θ deg.
26	0.0195	1.1	0.304	0.075	0.117	0.109	0.640	0.690	0.497	1.650	46.2
24	0.0254	1.4	0.396	0.097	0.151	0.140	0.643	0.693	0.495	1.649	46.2
22	0.0314	1.7	0.490	0.120	0.185	0.172	0.647	0.696	0.495	1.649	46.1
20	0.0374	2.1	0.583	0.143	0.220	0.205	0.650	0.699	0.495	1.648	46.0

GRADE 80: F <sub>y</sub> = 60 ksi, F <sub>u</sub> = 62 ksi												
Gage	I <sub>e+</sub> in <sup>4</sup> /ft	I <sub>e-</sub> in <sup>4</sup> /ft	I <sub>d+</sub> in <sup>4</sup> /ft	I <sub>d-</sub> in <sup>4</sup> /ft	S <sub>e+</sub> in <sup>3</sup> /ft	S <sub>e-</sub> in <sup>3</sup> /ft	M <sub>n+</sub> k-ft/ft	M <sub>n-</sub> k-ft/ft	M <sub>nxt+</sub> k-ft/ft	M <sub>nxt-</sub> k-ft/ft	V <sub>n</sub> k/ft	T <sub>n</sub> k/ft
26	0.073	0.073	0.074	0.074	0.099	0.103	0.495	0.515	0.585	0.545	2.463	18.24
24	0.097	0.096	0.097	0.096	0.137	0.138	0.685	0.690	0.755	0.700	4.582	23.76
22	0.120	0.120	0.120	0.120	0.172	0.171	0.860	0.855	0.925	0.860	6.991	29.40
20	0.143	0.143	0.143	0.143	0.204	0.204	1.020	1.020	1.100	1.025	8.513	34.98

R	w <sub>tf</sub>	w <sub>bf</sub>
in.	in.	in.
0.188	0.810	0.810



Web Perforated Profiles  
 PLB-36 AC, HSB-36 AC,  
 HSB-36-SS AC

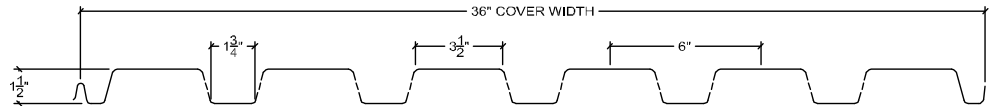

Gage	t in.	w <sub>dd</sub> psf	A <sub>g</sub> in <sup>2</sup> /ft	A <sub>n</sub> in <sup>2</sup> /ft	I <sub>xg</sub> in <sup>4</sup> /ft	S <sub>xb</sub> in <sup>3</sup> /ft	S <sub>xt</sub> in <sup>3</sup> /ft	y <sub>b</sub> in.	y <sub>t</sub> in.	r in.	h <sub>w</sub> in.	θ deg.
22	0.0299	1.9	0.506	0.493	0.187	0.205	0.303	0.913	0.617	0.616	1.240	75.1
20	0.0359	2.3	0.607	0.591	0.224	0.245	0.361	0.916	0.620	0.616	1.238	75.0
18	0.0478	2.9	0.807	0.786	0.297	0.322	0.475	0.923	0.625	0.615	1.233	74.7
16	0.0598	3.5	1.007	0.981	0.370	0.398	0.587	0.929	0.630	0.614	1.228	74.3

GRADE 50: F <sub>y</sub> = 50 ksi, F <sub>u</sub> = 65 ksi												
Gage	I <sub>e+</sub> in <sup>4</sup> /ft	I <sub>e-</sub> in <sup>4</sup> /ft	I <sub>d+</sub> in <sup>4</sup> /ft	I <sub>d-</sub> in <sup>4</sup> /ft	S <sub>e+</sub> in <sup>3</sup> /ft	S <sub>e-</sub> in <sup>3</sup> /ft	M <sub>n+</sub> k-ft/ft	M <sub>n-</sub> k-ft/ft	M <sub>nxt+</sub> k-ft/ft	M <sub>nxt-</sub> k-ft/ft	V <sub>n</sub> k/ft	T <sub>n</sub> k/ft
22	0.166	0.187	0.173	0.187	0.170	0.182	0.708	0.758	0.854	1.263	3.574	24.65
20	0.208	0.225	0.213	0.225	0.223	0.230	0.929	0.958	1.021	1.504	4.281	29.55
18	0.293	0.299	0.294	0.298	0.306	0.322	1.275	1.342	1.342	1.979	5.664	39.30
16	0.372	0.372	0.371	0.371	0.388	0.399	1.617	1.663	1.658	2.446	7.038	49.05

R	w <sub>tf</sub>	w <sub>bf</sub>
in.	in.	in.
0.188	3.125	1.375

d <sub>p</sub>	c <sub>p</sub>	W <sub>p</sub>
in.	in.	in.
0.156	0.433	0.806



Web Perforated Profiles

PLN3-32 AC, HSN3-32 AC,  
HSN3-32-SS AC,  
HSN3-32-NS AC

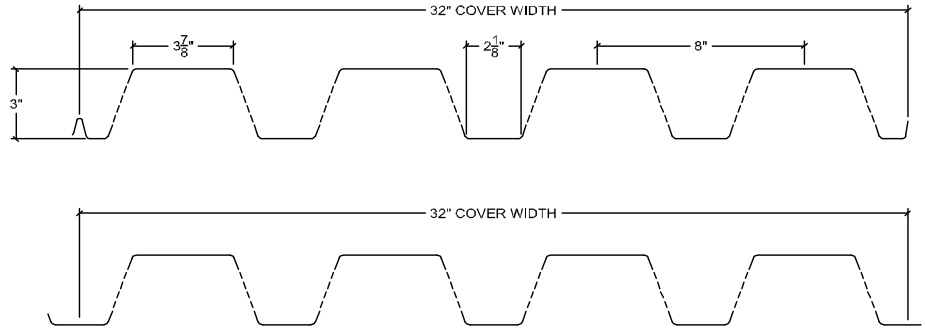

Gage	t in.	w <sub>dd</sub> psf	A <sub>g</sub> in <sup>2</sup> /ft	A <sub>n</sub> in <sup>2</sup> /ft	I <sub>xg</sub> in <sup>4</sup> /ft	S <sub>xb</sub> in <sup>3</sup> /ft	S <sub>xt</sub> in <sup>3</sup> /ft	y <sub>b</sub> in.	y <sub>t</sub> in.	r in.	h <sub>w</sub> in.	θ deg.
22	0.0299	2.0	0.567	0.538	0.752	0.446	0.560	1.687	1.343	1.182	2.879	71.2
20	0.0359	2.4	0.680	0.645	0.901	0.533	0.669	1.690	1.346	1.182	2.877	71.1
18	0.0478	3.1	0.905	0.858	1.197	0.705	0.886	1.697	1.351	1.181	2.872	71.0
16	0.0598	3.9	1.130	1.072	1.492	0.876	1.099	1.703	1.357	1.180	2.867	70.8

GRADE 50: F <sub>y</sub> = 50 ksi, F <sub>u</sub> = 65 ksi												
Gage	I <sub>e+</sub> in <sup>4</sup> /ft	I <sub>e-</sub> in <sup>4</sup> /ft	I <sub>d+</sub> in <sup>4</sup> /ft	I <sub>d-</sub> in <sup>4</sup> /ft	S <sub>e+</sub> in <sup>3</sup> /ft	S <sub>e-</sub> in <sup>3</sup> /ft	M <sub>n+</sub> k-ft/ft	M <sub>n-</sub> k-ft/ft	M <sub>nxt+</sub> k-ft/ft	M <sub>nxt-</sub> k-ft/ft	V <sub>n</sub> k/ft	T <sub>n</sub> k/ft
22	0.635	0.729	0.674	0.737	0.321	0.374	1.338	1.558	1.858	2.333	3.042	26.90
20	0.799	0.891	0.833	0.894	0.414	0.471	1.725	1.963	2.221	2.788	4.992	32.25
18	1.132	1.194	1.154	1.195	0.620	0.672	2.583	2.800	2.938	3.692	8.841	42.90
16	1.467	1.490	1.475	1.491	0.821	0.870	3.421	3.625	3.650	4.579	11.796	53.60

R	w <sub>tf</sub>	w <sub>br</sub>
in.	in.	in.
0.188	3.523	1.773

d <sub>p</sub>	c <sub>p</sub>	W <sub>p</sub>
in.	in.	in.
0.156	0.433	2.105





Web Perforated Profiles

PLN-24 AC, N-24 AC,  
N-24-SS AC

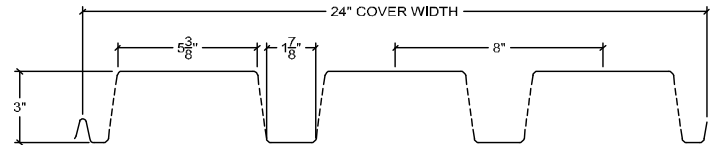

Gage	t in.	w <sub>dd</sub> psf	A <sub>g</sub> in <sup>2</sup> /ft	A <sub>n</sub> in <sup>2</sup> /ft	I <sub>xg</sub> in <sup>4</sup> /ft	S <sub>xb</sub> in <sup>3</sup> /ft	S <sub>xt</sub> in <sup>3</sup> /ft	y <sub>b</sub> in.	y <sub>t</sub> in.	r in.	h <sub>w</sub> in.	θ deg.
22	0.0299	2.2	0.617	0.590	0.819	0.443	0.693	1.849	1.181	1.178	2.672	82.4
20	0.0359	2.6	0.740	0.708	0.980	0.529	0.828	1.852	1.184	1.177	2.668	82.3
18	0.0478	3.5	0.983	0.941	1.301	0.699	1.095	1.860	1.188	1.176	2.661	82.1
16	0.0598	4.2	1.227	1.175	1.621	0.868	1.359	1.867	1.193	1.175	2.653	81.9

GRADE 50: F <sub>y</sub> = 50 ksi, F <sub>u</sub> = 65 ksi												
Gage	I <sub>e+</sub> in <sup>4</sup> /ft	I <sub>e-</sub> in <sup>4</sup> /ft	I <sub>d+</sub> in <sup>4</sup> /ft	I <sub>d-</sub> in <sup>4</sup> /ft	S <sub>e+</sub> in <sup>3</sup> /ft	S <sub>e-</sub> in <sup>3</sup> /ft	M <sub>n+</sub> k-ft/ft	M <sub>n-</sub> k-ft/ft	M <sub>nxt+</sub> k-ft/ft	M <sub>nxt-</sub> k-ft/ft	V <sub>n</sub> k/ft	T <sub>n</sub> k/ft
22	0.629	0.810	0.692	0.813	0.317	0.403	1.321	1.679	1.846	2.888	3.459	29.50
20	0.799	0.978	0.859	0.979	0.411	0.498	1.713	2.075	2.204	3.450	5.269	35.40
18	1.153	1.299	1.202	1.300	0.609	0.692	2.538	2.883	2.913	4.563	9.252	47.05
16	1.529	1.619	1.560	1.620	0.784	0.860	3.267	3.583	3.617	5.663	11.526	58.75

R	w <sub>tf</sub>	w <sub>bf</sub>
in.	in.	in.
0.188	4.946	1.446

d <sub>p</sub>	c <sub>p</sub>	W <sub>p</sub>
in.	in.	in.
0.156	0.433	1.888



Fully Perforated Profiles

(11% Open Area)

PLB-36 FP11, HSB-36 FP11,  
HSB-36-SS FP11

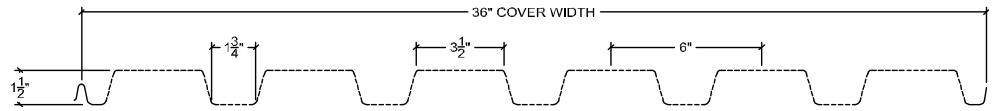

Gage	t in.	w <sub>dd</sub> psf	A <sub>g</sub> in <sup>2</sup> /ft	A <sub>n</sub> in <sup>2</sup> /ft	I <sub>xg</sub> in <sup>4</sup> /ft	S <sub>xb</sub> in <sup>3</sup> /ft	S <sub>xt</sub> in <sup>3</sup> /ft	y <sub>b</sub> in.	y <sub>t</sub> in.	r in.	h <sub>w</sub> in.	θ deg.
22	0.0299	1.7	0.506	0.447	0.170	0.186	0.276	0.913	0.617	0.617	1.240	75.1
20	0.0359	2.0	0.607	0.536	0.204	0.223	0.329	0.916	0.620	0.617	1.238	75.0
18	0.0478	2.6	0.807	0.712	0.270	0.293	0.432	0.923	0.625	0.616	1.233	74.7
16	0.0598	3.1	1.007	0.889	0.336	0.362	0.533	0.929	0.630	0.615	1.228	74.3

GRADE 50: F <sub>y</sub> = 50 ksi, F <sub>u</sub> = 65 ksi												
Gage	I <sub>e+</sub> in <sup>4</sup> /ft	I <sub>e-</sub> in <sup>4</sup> /ft	I <sub>d+</sub> in <sup>4</sup> /ft	I <sub>d-</sub> in <sup>4</sup> /ft	S <sub>e+</sub> in <sup>3</sup> /ft	S <sub>e-</sub> in <sup>3</sup> /ft	M <sub>n+</sub> k-ft/ft	M <sub>n-</sub> k-ft/ft	M <sub>nxt+</sub> k-ft/ft	M <sub>nxt-</sub> k-ft/ft	V <sub>n</sub> k/ft	T <sub>n</sub> k/ft
22	0.127	0.133	0.141	0.145	0.098	0.105	0.408	0.438	0.775	1.150	3.185	22.35
20	0.157	0.160	0.173	0.175	0.128	0.132	0.533	0.550	0.929	1.371	3.816	26.80
18	0.211	0.211	0.231	0.231	0.175	0.185	0.729	0.771	1.221	1.800	5.053	35.60
16	0.263	0.263	0.287	0.287	0.223	0.229	0.929	0.954	1.508	2.221	6.283	44.45

R	w <sub>tf</sub>	w <sub>bf</sub>
in.	in.	in.
0.188	3.125	1.375

d <sub>p</sub>	c <sub>p</sub>
in.	in.
0.156	0.433



Fully Perforated Profiles

(11% Open Area)

PLN3-32 FP11, HSN3-32 FP11,  
HSN3-32-SS FP11

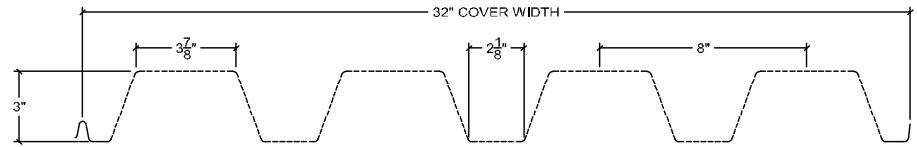

Gage	t in.	w <sub>dd</sub> psf	A <sub>g</sub> in <sup>2</sup> /ft	A <sub>n</sub> in <sup>2</sup> /ft	I <sub>xg</sub> in <sup>4</sup> /ft	S <sub>xb</sub> in <sup>3</sup> /ft	S <sub>xt</sub> in <sup>3</sup> /ft	y <sub>b</sub> in.	y <sub>t</sub> in.	r in.	h <sub>w</sub> in.	θ deg.
22	0.0299	1.8	0.567	0.501	0.706	0.418	0.526	1.687	1.343	1.187	2.879	71.2
20	0.0359	2.1	0.680	0.601	0.847	0.501	0.629	1.690	1.346	1.187	2.877	71.1
18	0.0478	2.8	0.905	0.799	1.124	0.662	0.832	1.697	1.351	1.186	2.872	71.0
16	0.0598	3.5	1.130	0.998	1.401	0.823	1.032	1.703	1.357	1.185	2.867	70.8

GRADE 50: F <sub>y</sub> = 50 ksi, F <sub>u</sub> = 65 ksi												
Gage	I <sub>e+</sub> in <sup>4</sup> /ft	I <sub>e-</sub> in <sup>4</sup> /ft	I <sub>d+</sub> in <sup>4</sup> /ft	I <sub>d-</sub> in <sup>4</sup> /ft	S <sub>e+</sub> in <sup>3</sup> /ft	S <sub>e-</sub> in <sup>3</sup> /ft	M <sub>n+</sub> k-ft/ft	M <sub>n-</sub> k-ft/ft	M <sub>nxt+</sub> k-ft/ft	M <sub>nxt-</sub> k-ft/ft	V <sub>n</sub> k/ft	T <sub>n</sub> k/ft
22	0.512	0.552	0.577	0.603	0.197	0.226	0.821	0.942	1.742	2.192	2.781	25.05
20	0.636	0.663	0.706	0.724	0.252	0.284	1.050	1.183	2.088	2.621	4.564	30.05
18	0.875	0.880	0.958	0.961	0.374	0.403	1.558	1.679	2.758	3.467	8.086	39.95
16	1.098	1.098	1.199	1.199	0.493	0.520	2.054	2.167	3.429	4.300	10.793	49.90

R	w <sub>tf</sub>	w <sub>bf</sub>
in.	in.	in.
0.188	3.523	1.773

d <sub>p</sub>	c <sub>p</sub>
in.	in.
0.156	0.433



Fully Perforated Profiles  
 (11% Open Area)  
 PLN-24 FP11, N-24 FP11,  
 N-24-SS FP11

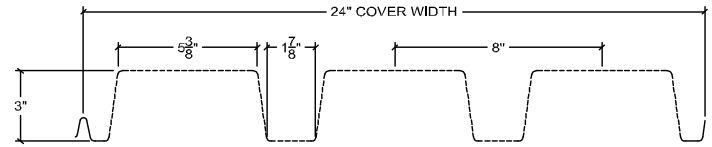

Gage	t in.	w <sub>dd</sub> psf	A <sub>g</sub> in <sup>2</sup> /ft	A <sub>n</sub> in <sup>2</sup> /ft	I <sub>xg</sub> in <sup>4</sup> /ft	S <sub>xb</sub> in <sup>3</sup> /ft	S <sub>xt</sub> in <sup>3</sup> /ft	y <sub>b</sub> in.	y <sub>t</sub> in.	r in.	h <sub>w</sub> in.	θ deg.
22	0.0299	2.0	0.617	0.545	0.761	0.412	0.644	1.849	1.181	1.182	2.672	82.4
20	0.0359	2.3	0.740	0.653	0.911	0.492	0.769	1.852	1.184	1.181	2.668	82.3
18	0.0478	3.1	0.983	0.868	1.209	0.650	1.018	1.860	1.188	1.180	2.661	82.1
16	0.0598	3.7	1.227	1.084	1.506	0.807	1.262	1.867	1.193	1.179	2.653	81.9

GRADE 50: F <sub>y</sub> = 50 ksi, F <sub>u</sub> = 65 ksi												
Gage	I <sub>e+</sub> in <sup>4</sup> /ft	I <sub>e-</sub> in <sup>4</sup> /ft	I <sub>d+</sub> in <sup>4</sup> /ft	I <sub>d-</sub> in <sup>4</sup> /ft	S <sub>e+</sub> in <sup>3</sup> /ft	S <sub>e-</sub> in <sup>3</sup> /ft	M <sub>n+</sub> k-ft/ft	M <sub>n-</sub> k-ft/ft	M <sub>nxt+</sub> k-ft/ft	M <sub>nxt-</sub> k-ft/ft	V <sub>n</sub> k/ft	T <sub>n</sub> k/ft
22	0.513	0.596	0.596	0.651	0.192	0.240	0.800	1.000	1.717	2.683	3.137	27.25
20	0.645	0.714	0.734	0.780	0.247	0.296	1.029	1.233	2.050	3.204	4.780	32.65
18	0.910	0.947	1.010	1.034	0.364	0.410	1.517	1.708	2.708	4.242	8.399	43.40
16	1.172	1.180	1.283	1.289	0.467	0.510	1.946	2.125	3.363	5.258	10.470	54.20

R	w <sub>tf</sub>	w <sub>bf</sub>
in.	in.	in.
0.188	4.946	1.446

d <sub>p</sub>	c <sub>p</sub>
in.	in.
0.156	0.433



Fully Perforated Profiles

(21% Open Area)

PLB-36 FP21, HSB-36 FP21,

HSB-36-SS FP21,

HSB-30-NS FP21

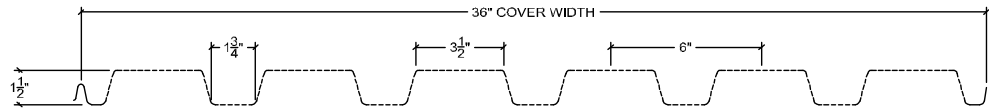

Gage	t in.	w <sub>dd</sub> psf	A <sub>g</sub> in <sup>2</sup> /ft	A <sub>n</sub> in <sup>2</sup> /ft	I <sub>xg</sub> in <sup>4</sup> /ft	S <sub>xb</sub> in <sup>3</sup> /ft	S <sub>xt</sub> in <sup>3</sup> /ft	y <sub>b</sub> in.	y <sub>t</sub> in.	r in.	h <sub>w</sub> in.	θ deg.
22	0.0299	1.5	0.506	0.396	0.151	0.165	0.245	0.913	0.617	0.618	1.240	75.1
20	0.0359	1.8	0.607	0.475	0.181	0.198	0.292	0.916	0.620	0.617	1.238	75.0
18	0.0478	2.3	0.807	0.631	0.239	0.259	0.382	0.923	0.625	0.615	1.233	74.7
16	0.0598	2.8	1.007	0.787	0.298	0.321	0.473	0.929	0.630	0.615	1.228	74.3

GRADE 50: F <sub>y</sub> = 50 ksi, F <sub>u</sub> = 65 ksi												
Gage	I <sub>e+</sub> in <sup>4</sup> /ft	I <sub>e-</sub> in <sup>4</sup> /ft	I <sub>d+</sub> in <sup>4</sup> /ft	I <sub>d-</sub> in <sup>4</sup> /ft	S <sub>e+</sub> in <sup>3</sup> /ft	S <sub>e-</sub> in <sup>3</sup> /ft	M <sub>n+</sub> k-ft/ft	M <sub>n-</sub> k-ft/ft	M <sub>nxt+</sub> k-ft/ft	M <sub>nxt-</sub> k-ft/ft	V <sub>n</sub> k/ft	T <sub>n</sub> k/ft
22	0.102	0.104	0.118	0.120	0.078	0.083	0.325	0.346	0.688	1.021	2.364	19.80
20	0.124	0.124	0.143	0.143	0.102	0.105	0.425	0.438	0.825	1.217	2.833	23.75
18	0.165	0.165	0.190	0.190	0.139	0.147	0.579	0.613	1.079	1.592	3.751	31.55
16	0.205	0.205	0.236	0.236	0.177	0.182	0.738	0.758	1.338	1.971	4.665	39.35

R	w <sub>tf</sub>	w <sub>bf</sub>
in.	in.	in.
0.188	3.125	1.375

d <sub>p</sub>	c <sub>p</sub>
in.	in.
0.156	0.326



Fully Perforated Profiles

(21% Open Area)

PLN3-32 FP21, HSN3-32 FP21,  
HSN3-32-SS FP21

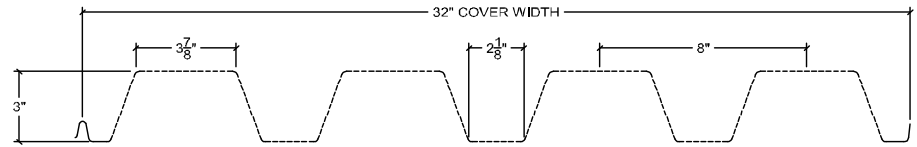

Gage	t in.	w <sub>dd</sub> psf	A <sub>g</sub> in <sup>2</sup> /ft	A <sub>n</sub> in <sup>2</sup> /ft	I <sub>xg</sub> in <sup>4</sup> /ft	S <sub>xb</sub> in <sup>3</sup> /ft	S <sub>xt</sub> in <sup>3</sup> /ft	y <sub>b</sub> in.	y <sub>t</sub> in.	r in.	h <sub>w</sub> in.	θ deg.
22	0.0299	1.6	0.567	0.443	0.626	0.371	0.466	1.687	1.343	1.189	2.879	71.2
20	0.0359	1.9	0.680	0.532	0.750	0.444	0.557	1.690	1.346	1.187	2.877	71.1
18	0.0478	2.4	0.905	0.707	0.995	0.586	0.736	1.697	1.351	1.186	2.872	71.0
16	0.0598	3.1	1.130	0.884	1.241	0.729	0.915	1.703	1.357	1.185	2.867	70.8

GRADE 50: F <sub>y</sub> = 50 ksi, F <sub>u</sub> = 65 ksi												
Gage	I <sub>e+</sub> in <sup>4</sup> /ft	I <sub>e-</sub> in <sup>4</sup> /ft	I <sub>d+</sub> in <sup>4</sup> /ft	I <sub>d-</sub> in <sup>4</sup> /ft	S <sub>e+</sub> in <sup>3</sup> /ft	S <sub>e-</sub> in <sup>3</sup> /ft	M <sub>n+</sub> k-ft/ft	M <sub>n-</sub> k-ft/ft	M <sub>nxt+</sub> k-ft/ft	M <sub>nxt-</sub> k-ft/ft	V <sub>n</sub> k/ft	T <sub>n</sub> k/ft
22	0.411	0.431	0.483	0.496	0.156	0.180	0.650	0.750	1.546	1.942	2.064	22.15
20	0.507	0.517	0.588	0.595	0.200	0.225	0.833	0.938	1.850	2.321	3.388	26.60
18	0.686	0.686	0.789	0.789	0.297	0.320	1.238	1.333	2.442	3.067	6.003	35.35
16	0.856	0.856	0.984	0.984	0.391	0.413	1.629	1.721	3.038	3.813	8.012	44.20

R	w <sub>tf</sub>	w <sub>bf</sub>
in.	in.	in.
0.188	3.523	1.773

d <sub>p</sub>	c <sub>p</sub>
in.	in.
0.156	0.326



Fully Perforated Profiles  
 (21% Open Area)  
 PLN-24 FP21, N-24 FP21,  
 N-24-SS FP21

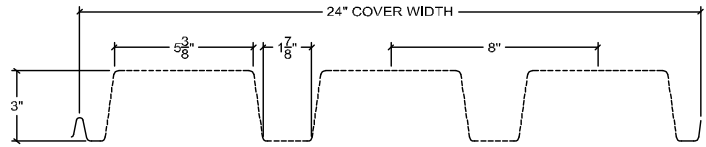

Gage	t in.	w <sub>dd</sub> psf	A <sub>g</sub> in <sup>2</sup> /ft	A <sub>n</sub> in <sup>2</sup> /ft	I <sub>xg</sub> in <sup>4</sup> /ft	S <sub>xb</sub> in <sup>3</sup> /ft	S <sub>xt</sub> in <sup>3</sup> /ft	y <sub>b</sub> in.	y <sub>t</sub> in.	r in.	h <sub>w</sub> in.	θ deg.
22	0.0299	1.7	0.617	0.482	0.674	0.365	0.571	1.849	1.181	1.183	2.672	82.4
20	0.0359	2.1	0.740	0.578	0.807	0.436	0.682	1.852	1.184	1.182	2.668	82.3
18	0.0478	2.8	0.983	0.769	1.071	0.576	0.902	1.860	1.188	1.180	2.661	82.1
16	0.0598	3.3	1.227	0.960	1.334	0.715	1.118	1.867	1.193	1.179	2.653	81.9

GRADE 50: F <sub>y</sub> = 50 ksi, F <sub>u</sub> = 65 ksi												
Gage	I <sub>e+</sub> in <sup>4</sup> /ft	I <sub>e-</sub> in <sup>4</sup> /ft	I <sub>d+</sub> in <sup>4</sup> /ft	I <sub>d-</sub> in <sup>4</sup> /ft	S <sub>e+</sub> in <sup>3</sup> /ft	S <sub>e-</sub> in <sup>3</sup> /ft	M <sub>n+</sub> k-ft/ft	M <sub>n-</sub> k-ft/ft	M <sub>nxt+</sub> k-ft/ft	M <sub>nxt-</sub> k-ft/ft	V <sub>n</sub> k/ft	T <sub>n</sub> k/ft
22	0.415	0.465	0.501	0.535	0.152	0.190	0.633	0.792	1.521	2.379	2.329	24.10
20	0.520	0.557	0.616	0.640	0.196	0.235	0.817	0.979	1.817	2.842	3.549	28.90
18	0.725	0.738	0.840	0.849	0.289	0.326	1.204	1.358	2.400	3.758	6.235	38.45
16	0.920	0.920	1.058	1.058	0.371	0.405	1.546	1.688	2.979	4.658	7.773	48.00

R	w <sub>tf</sub>	w <sub>bf</sub>
in.	in.	in.
0.188	4.946	1.446

d <sub>p</sub>	c <sub>p</sub>
in.	in.
0.156	0.326





Non-Embossed Profiles

PLBCD-36, HSBCD-36

Embossed Profiles

PLBCD-36 FormLok,

BCD-36 FormLok

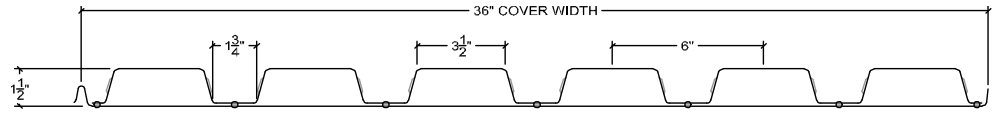

Gage	t in.	t <sub>b</sub> in.	w <sub>dd</sub> psf	A <sub>g</sub> in <sup>2</sup> /ft	I <sub>xg</sub> in <sup>4</sup> /ft	S <sub>xb</sub> in <sup>3</sup> /ft	S <sub>xt</sub> in <sup>3</sup> /ft	y <sub>b</sub> in.	y <sub>t</sub> in.	r in.	h <sub>w</sub> in.	θ deg.	K <sub>min</sub> -
20/20	0.0359	0.0359	3.6	1.028	0.448	0.785	0.448	0.571	1.001	0.660	1.238	75.0	1.000
20/18	0.0359	0.0478	4.1	1.179	0.490	0.953	0.458	0.514	1.070	0.645	1.238	75.0	1.000
18/20	0.0478	0.0359	4.1	1.216	0.550	0.861	0.582	0.639	0.945	0.673	1.233	74.7	1.000
18/18	0.0478	0.0478	4.6	1.367	0.603	1.034	0.596	0.583	1.012	0.664	1.233	74.7	1.000
18/16	0.0478	0.0598	5.1	1.520	0.649	1.202	0.608	0.540	1.068	0.653	1.233	74.7	1.000
16/18	0.0598	0.0478	5.3	1.556	0.708	1.110	0.730	0.638	0.970	0.675	1.228	74.3	1.000
16/16	0.0598	0.0598	5.8	1.709	0.763	1.280	0.745	0.596	1.024	0.668	1.228	74.3	1.000

GRADE 50: F <sub>y</sub> = 50 ksi, F <sub>u</sub> = 65 ksi														
Gage	I <sub>e+</sub> in <sup>4</sup> /ft	I <sub>e-</sub> in <sup>4</sup> /ft	I <sub>d+</sub> in <sup>4</sup> /ft	I <sub>d-</sub> in <sup>4</sup> /ft	S <sub>e+</sub> in <sup>3</sup> /ft	S <sub>e-</sub> in <sup>3</sup> /ft	M <sub>n+</sub> k-ft/ft	M <sub>n-</sub> k-ft/ft	M <sub>nxt+</sub> k-ft/ft	M <sub>nxt-</sub> k-ft/ft	V <sub>n</sub> k/ft	T <sub>n</sub> k/ft	V <sub>nn</sub> k/ft	V <sub>ni</sub> k/ft
20/20	0.400	0.280	0.416	0.336	0.279	0.382	1.163	1.592	3.271	1.867	5.152	51.40	0.799	1.200
20/18	0.436	0.318	0.454	0.375	0.287	0.428	1.196	1.783	3.971	1.908	5.152	58.95	0.748	0.868
18/20	0.528	0.354	0.535	0.419	0.417	0.453	1.738	1.888	3.588	2.425	6.822	60.80	0.866	1.439
18/18	0.579	0.391	0.587	0.462	0.428	0.552	1.783	2.300	4.308	2.483	6.822	68.35	1.215	1.567
18/16	0.622	0.443	0.631	0.512	0.437	0.575	1.821	2.396	5.008	2.533	6.822	76.00	1.154	1.231
16/18	0.702	0.467	0.704	0.547	0.587	0.629	2.446	2.621	4.625	3.042	8.483	77.80	1.291	1.779
16/16	0.757	0.517	0.759	0.599	0.599	0.700	2.496	2.917	5.333	3.104	8.483	85.45	1.686	1.928

R	w <sub>tf</sub>	w <sub>bf</sub>	w <sub>bp1</sub>	S <sub>bp</sub>
in.	in.	in.	in.	in.
0.188	3.125	1.375	6.000	6.000



Non-Embossed Profiles

PLN3CD-32, HSN3CD-32

Embossed Profiles

PLN3CD-32 FormLok,

N3CD-32 FormLok

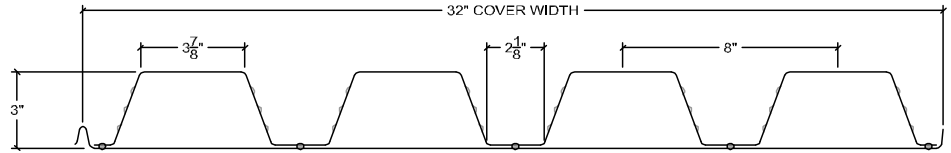

Gage	t in.	t <sub>b</sub> in.	w <sub>dd</sub> psf	A <sub>g</sub> in <sup>2</sup> /ft	I <sub>xg</sub> in <sup>4</sup> /ft	S <sub>xb</sub> in <sup>3</sup> /ft	S <sub>xt</sub> in <sup>3</sup> /ft	y <sub>b</sub> in.	y <sub>t</sub> in.	r in.	h <sub>w</sub> in.	θ deg.	K <sub>min</sub> -
20/20	0.0359	0.0359	3.9	1.099	1.714	1.593	0.859	1.076	1.996	1.249	2.877	71.1	1.000
20/18	0.0359	0.0478	4.4	1.251	1.863	1.937	0.878	0.962	2.122	1.220	2.877	71.1	1.000
18/20	0.0478	0.0359	4.6	1.310	2.105	1.757	1.116	1.198	1.886	1.268	2.872	71.0	1.000
18/18	0.0478	0.0478	5.1	1.463	2.294	2.107	1.143	1.089	2.007	1.252	2.872	71.0	1.000
18/16	0.0478	0.0598	5.7	1.616	2.452	2.450	1.164	1.001	2.107	1.232	2.872	71.0	1.000
16/18	0.0598	0.0478	5.9	1.675	2.694	2.272	1.402	1.186	1.922	1.268	2.867	70.8	1.000
16/16	0.0598	0.0598	6.4	1.828	2.884	2.617	1.429	1.102	2.018	1.256	2.867	70.8	1.000

GRADE 50: F <sub>y</sub> = 50 ksi, F <sub>u</sub> = 65 ksi														
Gage	I <sub>e+</sub> in <sup>4</sup> /ft	I <sub>e-</sub> in <sup>4</sup> /ft	I <sub>d+</sub> in <sup>4</sup> /ft	I <sub>d-</sub> in <sup>4</sup> /ft	S <sub>e+</sub> in <sup>3</sup> /ft	S <sub>e-</sub> in <sup>3</sup> /ft	M <sub>n+</sub> k-ft/ft	M <sub>n-</sub> k-ft/ft	M <sub>nx+</sub> k-ft/ft	M <sub>nx-</sub> k-ft/ft	V <sub>n</sub> k/ft	T <sub>n</sub> k/ft	V <sub>nn</sub> k/ft	V <sub>ni</sub> k/ft
20/20	1.511	1.172	1.579	1.353	0.505	0.709	2.104	2.954	6.638	3.579	6.127	54.95	1.241	2.786
20/18	1.643	1.394	1.716	1.550	0.503	0.801	2.096	3.338	8.071	3.658	6.127	62.55	1.149	1.755
18/20	1.973	1.474	2.017	1.684	0.804	0.869	3.350	3.621	7.321	4.650	10.917	65.50	1.361	3.379
18/18	2.144	1.699	2.194	1.897	0.824	1.030	3.433	4.292	8.779	4.763	10.917	73.15	1.887	3.351
18/16	2.293	1.997	2.346	2.149	0.829	1.077	3.454	4.488	10.208	4.850	10.917	80.80	1.776	2.599
16/18	2.631	2.007	2.652	2.236	1.107	1.210	4.613	5.042	9.467	5.842	14.572	83.75	2.025	3.958
16/16	2.815	2.316	2.838	2.505	1.129	1.314	4.704	5.475	10.904	5.954	14.572	91.40	2.620	4.076

R	w <sub>tf</sub>	w <sub>bf</sub>	w <sub>bp1</sub>	S <sub>bp</sub>
in.	in.	in.	in.	in.
0.188	3.523	1.773	8.000	6.000



Non-Embossed Profiles

PLNCD-24, NCD-24

Embossed Profiles

PLNCD-24 FormLok,

NCD-24 FormLok

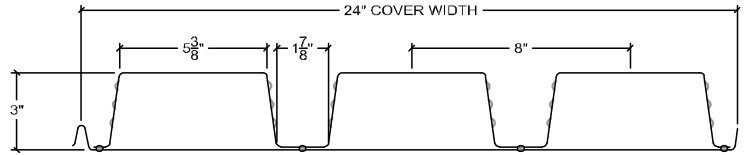

Gage	t in.	t <sub>b</sub> in.	w <sub>dd</sub> psf	A <sub>g</sub> in <sup>2</sup> /ft	I <sub>xg</sub> in <sup>4</sup> /ft	S <sub>xb</sub> in <sup>3</sup> /ft	S <sub>xt</sub> in <sup>3</sup> /ft	y <sub>b</sub> in.	y <sub>t</sub> in.	r in.	h <sub>w</sub> in.	θ deg.	K <sub>min</sub> -
20/20	0.0359	0.0359	4.1	1.152	1.961	1.611	1.057	1.217	1.855	1.305	2.668	82.3	1.000
20/18	0.0359	0.0478	4.6	1.308	2.154	1.976	1.080	1.090	1.994	1.283	2.668	82.3	1.000
18/20	0.0478	0.0359	4.8	1.376	2.381	1.762	1.374	1.351	1.733	1.315	2.661	82.1	1.000
18/18	0.0478	0.0478	5.3	1.532	2.624	2.133	1.406	1.230	1.866	1.309	2.661	82.1	1.000
18/16	0.0478	0.0598	5.8	1.689	2.829	2.499	1.432	1.132	1.976	1.294	2.661	82.1	1.000
16/18	0.0598	0.0478	6.1	1.757	3.054	2.286	1.724	1.336	1.771	1.318	2.653	81.9	0.994
16/16	0.0598	0.0598	6.6	1.914	3.299	2.654	1.758	1.243	1.877	1.313	2.653	81.9	0.994

GRADE 50: F <sub>y</sub> = 50 ksi, F <sub>u</sub> = 65 ksi														
Gage	I <sub>e+</sub> in <sup>4</sup> /ft	I <sub>e-</sub> in <sup>4</sup> /ft	I <sub>d+</sub> in <sup>4</sup> /ft	I <sub>d-</sub> in <sup>4</sup> /ft	S <sub>e+</sub> in <sup>3</sup> /ft	S <sub>e-</sub> in <sup>3</sup> /ft	M <sub>n+</sub> k-ft/ft	M <sub>n-</sub> k-ft/ft	M <sub>next+</sub> k-ft/ft	M <sub>next-</sub> k-ft/ft	V <sub>n</sub> k/ft	T <sub>n</sub> k/ft	V <sub>nn</sub> k/ft	V <sub>ni</sub> k/ft
20/20	1.541	1.211	1.681	1.461	0.518	0.706	2.158	2.942	6.713	4.404	6.418	57.60	1.313	2.441
20/18	1.685	1.356	1.841	1.622	0.515	0.909	2.146	3.788	8.233	4.500	6.418	65.40	1.226	1.688
18/20	2.048	1.519	2.159	1.806	0.805	0.852	3.354	3.550	7.342	5.725	11.339	68.80	1.428	2.943
18/18	2.241	1.679	2.369	1.994	0.826	1.055	3.442	4.396	8.888	5.858	11.339	76.60	1.998	2.996
18/16	2.402	1.845	2.544	2.173	0.843	1.318	3.513	5.492	10.413	5.967	11.339	84.45	1.892	2.271
16/18	2.795	1.994	2.881	2.347	1.121	1.199	4.671	4.996	9.525	7.183	14.136	87.85	2.128	3.420
16/16	3.009	2.174	3.106	2.549	1.144	1.475	4.767	6.146	11.058	7.325	14.136	95.70	2.774	3.521

R	w <sub>tf</sub>	w <sub>bf</sub>	w <sub>bp1</sub>	S <sub>bp</sub>
in.	in.	in.	in.	in.
0.188	4.946	1.446	8.000	6.000



Embossed Profiles  
 PLW2CD-36 FormLok,  
 W2CD-36 FormLok

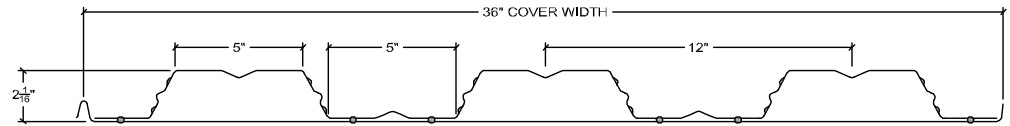

Gage	t in.	t <sub>b</sub> in.	w <sub>dd</sub> psf	A <sub>g</sub> in <sup>2</sup> /ft	I <sub>xg</sub> in <sup>4</sup> /ft	S <sub>xb</sub> in <sup>3</sup> /ft	S <sub>xt</sub> in <sup>3</sup> /ft	y <sub>b</sub> in.	y <sub>t</sub> in.	r in.	h <sub>w</sub> in.	θ deg.	K <sub>min</sub> -
20/20	0.0360	0.0359	3.4	0.957	0.690	1.099	0.458	0.628	1.506	0.849	2.047	63.6	1.000
20/18	0.0360	0.0478	3.8	1.108	0.740	1.326	0.466	0.558	1.588	0.817	2.047	63.6	1.000
18/20	0.0470	0.0359	3.9	1.109	0.848	1.206	0.588	0.703	1.442	0.874	2.044	63.5	1.000
18/18	0.0470	0.0478	4.3	1.261	0.912	1.438	0.599	0.634	1.523	0.850	2.044	63.5	1.000
18/16	0.0470	0.0598	4.8	1.413	0.965	1.661	0.608	0.581	1.588	0.826	2.044	63.5	1.000
16/18	0.0590	0.0478	4.9	1.427	1.088	1.554	0.741	0.700	1.469	0.873	2.041	63.3	0.854
16/16	0.0590	0.0598	5.4	1.580	1.154	1.784	0.752	0.647	1.534	0.855	2.041	63.3	0.854

GRADE 50: F <sub>y</sub> = 50 ksi, F <sub>u</sub> = 65 ksi														
Gage	I <sub>e+</sub> in <sup>4</sup> /ft	I <sub>e-</sub> in <sup>4</sup> /ft	I <sub>d+</sub> in <sup>4</sup> /ft	I <sub>d-</sub> in <sup>4</sup> /ft	S <sub>e+</sub> in <sup>3</sup> /ft	S <sub>e-</sub> in <sup>3</sup> /ft	M <sub>n+</sub> k-ft/ft	M <sub>n-</sub> k-ft/ft	M <sub>nxt+</sub> k-ft/ft	M <sub>nxt-</sub> k-ft/ft	V <sub>n</sub> k/ft	T <sub>n</sub> k/ft	V <sub>nn</sub> k/ft	V <sub>ni</sub> k/ft
20/20	0.655	0.497	0.667	0.561	0.363	0.429	1.513	1.788	4.579	1.908	3.911	47.85	0.949	1.443
20/18	0.700	0.552	0.713	0.615	0.372	0.446	1.550	1.858	5.525	1.942	3.911	55.40	0.885	1.019
18/20	0.847	0.619	0.847	0.695	0.526	0.549	2.192	2.288	5.025	2.450	5.158	55.45	1.032	1.774
18/18	0.911	0.678	0.911	0.756	0.536	0.570	2.233	2.375	5.992	2.496	5.158	63.05	1.400	1.741
18/16	0.964	0.792	0.964	0.850	0.544	0.586	2.267	2.442	6.921	2.533	5.158	70.65	1.320	1.519
16/18	1.087	0.813	1.087	0.905	0.704	0.702	2.933	2.925	6.475	3.088	6.455	71.35	1.499	2.036
16/16	1.152	0.883	1.153	0.973	0.714	0.722	2.975	3.008	7.433	3.133	6.455	79.00	1.953	2.231

Gage	A <sub>gtf</sub> in <sup>2</sup>	A <sub>stf</sub> in <sup>2</sup>	I <sub>sptf</sub> in <sup>4</sup>	A <sub>gbf</sub> in <sup>2</sup>	A <sub>sbf</sub> in <sup>2</sup>	I <sub>spbf</sub> in <sup>4</sup>
20/xx	0.177	0.043	0.001	0.177	0.043	0.001
18/xx	0.231	0.056	0.002	0.231	0.056	0.002
16/xx	0.289	0.071	0.002	0.289	0.071	0.002

b <sub>otf</sub> in.	b <sub>ptf</sub> in.	c <sub>stf</sub> in.	b <sub>obf</sub> in.	b <sub>pbf</sub> in.	c <sub>sbf</sub> in.
4.696	1.848	2.348	4.696	1.848	2.348

R in.	w <sub>bp1</sub> in.	w <sub>bp2</sub> in.	s <sub>bp</sub> in.
0.188	9.250	2.750	6.000



Embossed Profiles

PLW3CD-36 FormLok,

W3CD-36 FormLok

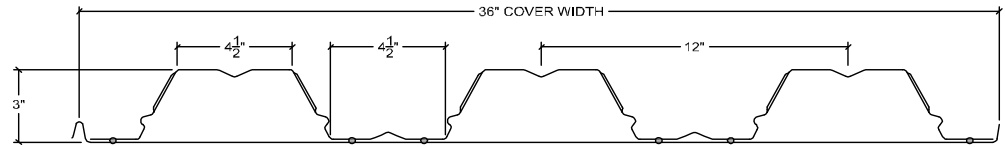

Gage	t in.	t <sub>b</sub> in.	w <sub>dd</sub> psf	A <sub>g</sub> in <sup>2</sup> /ft	I <sub>xg</sub> in <sup>4</sup> /ft	S <sub>xb</sub> in <sup>3</sup> /ft	S <sub>xt</sub> in <sup>3</sup> /ft	y <sub>b</sub> in.	y <sub>t</sub> in.	r in.	h <sub>w</sub> in.	θ deg.	K <sub>min</sub> -
20/20	0.0359	0.0359	3.6	1.002	1.456	1.598	0.674	0.911	2.161	1.205	3.112	63.1	0.000
20/18	0.0359	0.0478	4.0	1.153	1.562	1.936	0.686	0.807	2.277	1.164	3.112	63.1	0.000
18/20	0.0478	0.0359	4.1	1.182	1.814	1.771	0.881	1.024	2.060	1.239	3.108	63.0	0.000
18/18	0.0478	0.0478	4.6	1.334	1.950	2.113	0.897	0.923	2.173	1.209	3.108	63.0	0.000
18/16	0.0478	0.0598	5.0	1.486	2.063	2.447	0.911	0.843	2.264	1.178	3.108	63.0	0.000
16/18	0.0598	0.0478	5.2	1.515	2.317	2.287	1.106	1.013	2.095	1.237	3.105	62.9	0.000
16/16	0.0598	0.0598	5.7	1.668	2.454	2.625	1.124	0.935	2.184	1.213	3.105	62.9	0.000

GRADE 50: F <sub>y</sub> = 50 ksi, F <sub>u</sub> = 65 ksi														
Gage	I <sub>e+</sub> in <sup>4</sup> /ft	I <sub>e-</sub> in <sup>4</sup> /ft	I <sub>d+</sub> in <sup>4</sup> /ft	I <sub>d-</sub> in <sup>4</sup> /ft	S <sub>e+</sub> in <sup>3</sup> /ft	S <sub>e-</sub> in <sup>3</sup> /ft	M <sub>n+</sub> k-ft/ft	M <sub>n-</sub> k-ft/ft	M <sub>nxt+</sub> k-ft/ft	M <sub>nxt-</sub> k-ft/ft	V <sub>n</sub> k/ft	T <sub>n</sub> k/ft	V <sub>nn</sub> k/ft	V <sub>ni</sub> k/ft
20/20	1.455	1.050	1.455	1.185	0.542	0.625	2.258	2.604	6.658	2.808	3.776	50.10	1.342	2.142
20/18	1.550	1.163	1.554	1.296	0.541	0.652	2.254	2.717	8.067	2.858	3.776	57.65	1.240	1.449
18/20	1.813	1.331	1.813	1.492	0.852	0.813	3.550	3.388	7.379	3.671	6.858	59.10	1.477	2.753
18/18	1.949	1.452	1.949	1.618	0.862	0.846	3.592	3.525	8.804	3.738	6.858	66.70	2.042	2.689
18/16	2.061	1.688	2.062	1.813	0.859	0.874	3.579	3.642	10.196	3.796	6.858	74.30	1.917	2.246
16/18	2.315	1.738	2.316	1.931	1.105	1.037	4.604	4.321	9.529	4.608	9.918	75.75	2.195	3.183
16/16	2.452	1.882	2.453	2.073	1.123	1.073	4.679	4.471	10.938	4.683	9.918	83.40	2.834	3.304

Gage	A <sub>gtf</sub> in <sup>2</sup>	A <sub>stf</sub> in <sup>2</sup>	I <sub>sptf</sub> in <sup>4</sup>	A <sub>gbf</sub> in <sup>2</sup>	A <sub>sbf</sub> in <sup>2</sup>	I <sub>spbf</sub> in <sup>4</sup>
20/xx	0.159	0.043	0.001	0.159	0.043	0.001
18/xx	0.211	0.057	0.002	0.211	0.057	0.002
16/xx	0.263	0.072	0.002	0.263	0.072	0.002

b <sub>otf</sub> in.	b <sub>ptf</sub> in.	c <sub>stf</sub> in.	b <sub>obf</sub> in.	b <sub>pbf</sub> in.	c <sub>sbf</sub> in.
4.198	1.599	2.099	4.198	1.599	2.099

R in.	w <sub>bp1</sub> in.	w <sub>bp2</sub> in.	s <sub>bp</sub> in.
0.188	9.250	2.750	6.000



# EVALUATION REPORT

Number:

2018

Originally Issued: 07/11/2019

Revised: 01/04/2021

Valid Through: 07/31/2021

Page 50 of 54

Non-Embossed Profiles

PLBCD-36 AC, HSBCD-36 AC

Embossed Profiles

PLBCD-36 AC FormLok,

BCD-36 AC FormLok

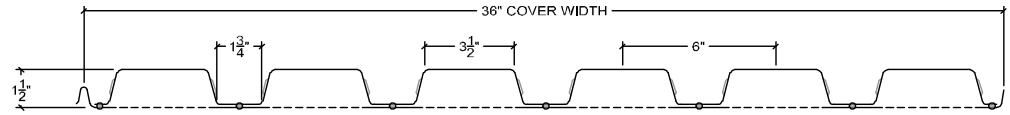

Gage	t in.	t <sub>b</sub> in.	w <sub>dd</sub> psf	A <sub>g</sub> in <sup>2</sup> /ft	A <sub>n</sub> in <sup>2</sup> /ft	I <sub>xg</sub> in <sup>4</sup> /ft	S <sub>xb</sub> in <sup>3</sup> /ft	S <sub>xt</sub> in <sup>3</sup> /ft	y <sub>b</sub> in.	y <sub>t</sub> in.	r in.	h <sub>w</sub> in.	θ deg.	K <sub>min</sub> -
20/20	0.0359	0.0359	3.6	1.028	0.988	0.435	0.734	0.444	0.593	0.979	0.664	1.238	75.0	1.000
20/18	0.0359	0.0478	4.1	1.179	1.127	0.477	0.888	0.456	0.537	1.047	0.651	1.238	75.0	1.000
18/20	0.0478	0.0359	4.1	1.216	1.176	0.534	0.809	0.578	0.660	0.924	0.674	1.233	74.7	1.000
18/18	0.0478	0.0478	4.6	1.367	1.314	0.586	0.967	0.592	0.606	0.990	0.668	1.233	74.7	1.000
18/16	0.0478	0.0598	5.1	1.520	1.454	0.631	1.121	0.604	0.563	1.045	0.659	1.233	74.7	1.000
16/18	0.0598	0.0478	5.3	1.556	1.503	0.687	1.041	0.725	0.660	0.948	0.676	1.228	74.3	1.000
16/16	0.0598	0.0598	5.8	1.709	1.642	0.741	1.197	0.740	0.619	1.001	0.672	1.228	74.3	1.000

GRADE 50: F <sub>y</sub> = 50 ksi, F <sub>u</sub> = 65 ksi														
Gage	I <sub>e+</sub> in <sup>4</sup> /ft	I <sub>e-</sub> in <sup>4</sup> /ft	I <sub>d+</sub> in <sup>4</sup> /ft	I <sub>d-</sub> in <sup>4</sup> /ft	S <sub>e+</sub> in <sup>3</sup> /ft	S <sub>e-</sub> in <sup>3</sup> /ft	M <sub>n+</sub> k-ft/ft	M <sub>n-</sub> k-ft/ft	M <sub>nx+</sub> k-ft/ft	M <sub>nx-</sub> k-ft/ft	V <sub>n</sub> k/ft	T <sub>n</sub> k/ft	V <sub>nn</sub> k/ft	V <sub>ni</sub> k/ft
20/20	0.390	0.330	0.405	0.365	0.277	0.382	1.154	1.592	3.058	1.850	5.152	49.40	0.820	1.415
20/18	0.425	0.394	0.442	0.422	0.285	0.428	1.188	1.783	3.700	1.900	5.152	56.35	0.764	1.076
18/20	0.513	0.408	0.520	0.450	0.414	0.453	1.725	1.888	3.371	2.408	6.822	58.80	0.894	1.656
18/18	0.562	0.473	0.570	0.511	0.425	0.552	1.771	2.300	4.029	2.467	6.822	65.70	1.247	1.894
18/16	0.605	0.552	0.614	0.578	0.434	0.575	1.808	2.396	4.671	2.517	6.822	72.70	1.179	1.535
16/18	0.682	0.554	0.684	0.598	0.583	0.629	2.429	2.621	4.338	3.021	8.483	75.15	1.331	2.111
16/16	0.735	0.635	0.737	0.670	0.595	0.700	2.479	2.917	4.988	3.083	8.483	82.10	1.730	2.368

R	w <sub>tf</sub>	w <sub>bf</sub>	w <sub>bp1</sub>	S <sub>bp</sub>
in.	in.	in.	in.	in.
0.188	3.125	1.375	6.000	6.000

d <sub>p</sub>	c <sub>p</sub>	P <sub>p</sub>
in.	in.	in.
0.156	0.433	3.620



Non-Embossed Profiles

PLN3CD-32 AC, HSN3CD-32 AC

Embossed Profiles

PLN3CD-32 AC FormLok,

N3CD-32 AC FormLok

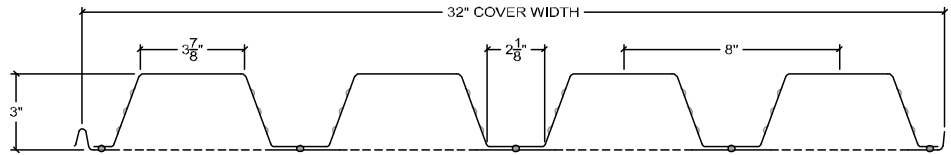

Gage	t in.	t <sub>b</sub> in.	w <sub>dd</sub> psf	A <sub>g</sub> in <sup>2</sup> /ft	A <sub>n</sub> in <sup>2</sup> /ft	I <sub>xg</sub> in <sup>4</sup> /ft	S <sub>xb</sub> in <sup>3</sup> /ft	S <sub>xt</sub> in <sup>3</sup> /ft	y <sub>b</sub> in.	y <sub>t</sub> in.	r in.	h <sub>w</sub> in.	θ deg.	K <sub>min</sub> -
20/20	0.0359	0.0359	3.9	1.099	1.054	1.661	1.480	0.852	1.122	1.950	1.255	2.877	71.1	1.000
20/18	0.0359	0.0478	4.4	1.251	1.191	1.807	1.791	0.871	1.009	2.074	1.232	2.877	71.1	1.000
18/20	0.0478	0.0359	4.6	1.310	1.265	2.039	1.643	1.106	1.241	1.843	1.270	2.872	71.0	1.000
18/18	0.0478	0.0478	5.1	1.463	1.402	2.222	1.958	1.133	1.135	1.961	1.259	2.872	71.0	1.000
18/16	0.0478	0.0598	5.7	1.616	1.540	2.377	2.266	1.154	1.049	2.059	1.242	2.872	71.0	1.000
16/18	0.0598	0.0478	5.9	1.675	1.614	2.609	2.121	1.389	1.230	1.878	1.271	2.867	70.8	1.000
16/16	0.0598	0.0598	6.4	1.828	1.752	2.793	2.433	1.416	1.148	1.972	1.263	2.867	70.8	1.000

GRADE 50: F <sub>y</sub> = 50 ksi, F <sub>u</sub> = 65 ksi														
Gage	I <sub>e+</sub> in <sup>4</sup> /ft	I <sub>e-</sub> in <sup>4</sup> /ft	I <sub>d+</sub> in <sup>4</sup> /ft	I <sub>d-</sub> in <sup>4</sup> /ft	S <sub>e+</sub> in <sup>3</sup> /ft	S <sub>e-</sub> in <sup>3</sup> /ft	M <sub>n+</sub> k-ft/ft	M <sub>n-</sub> k-ft/ft	M <sub>next+</sub> k-ft/ft	M <sub>next-</sub> k-ft/ft	V <sub>n</sub> k/ft	T <sub>n</sub> k/ft	V <sub>nn</sub> k/ft	V <sub>ni</sub> k/ft
20/20	1.464	1.172	1.530	1.335	0.507	0.709	2.113	2.954	6.167	3.550	6.127	52.70	1.283	2.786
20/18	1.593	1.394	1.664	1.532	0.505	0.801	2.104	3.338	7.463	3.629	6.127	59.55	1.180	1.755
18/20	1.913	1.474	1.955	1.662	0.796	0.869	3.317	3.621	6.846	4.608	10.917	63.25	1.417	3.379
18/18	2.080	1.699	2.127	1.873	0.817	1.030	3.404	4.292	8.158	4.721	10.917	70.10	1.951	3.351
18/16	2.221	1.997	2.273	2.124	0.832	1.077	3.467	4.488	9.442	4.808	10.917	77.00	1.826	2.599
16/18	2.549	2.007	2.569	2.208	1.096	1.210	4.567	5.042	8.838	5.788	14.572	80.70	2.103	3.958
16/16	2.727	2.316	2.749	2.475	1.119	1.314	4.663	5.475	10.138	5.900	14.572	87.60	2.707	4.076

R	w <sub>tf</sub>	w <sub>bf</sub>	w <sub>bp1</sub>	S <sub>bp</sub>
in.	in.	in.	in.	in.
0.188	3.523	1.773	8.000	6.000

d <sub>p</sub>	c <sub>p</sub>	P <sub>p</sub>
in.	in.	in.
0.156	0.433	5.569





# EVALUATION REPORT

Number:

2018

Originally Issued: 07/11/2019

Revised: 01/04/2021

Valid Through: 07/31/2021

Page 52 of 54

Non-Embossed Profiles

PLNCD-24 AC, NCD-24 AC

Embossed Profiles

PLNCD-24 AC FormLok,

NCD-24 AC FormLok

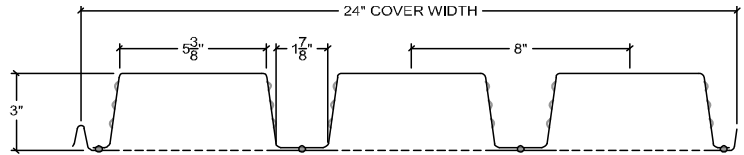

Gage	t in.	t <sub>b</sub> in.	w <sub>dd</sub> psf	A <sub>g</sub> in <sup>2</sup> /ft	A <sub>n</sub> in <sup>2</sup> /ft	I <sub>xg</sub> in <sup>4</sup> /ft	S <sub>xb</sub> in <sup>3</sup> /ft	S <sub>xt</sub> in <sup>3</sup> /ft	y <sub>b</sub> in.	y <sub>t</sub> in.	r in.	h <sub>w</sub> in.	θ deg.	K <sub>min</sub> -
20/20	0.0359	0.0359	4.1	1.152	1.108	1.896	1.499	1.049	1.265	1.807	1.308	2.668	82.3	1.000
20/18	0.0359	0.0478	4.6	1.308	1.249	2.085	1.831	1.073	1.139	1.944	1.292	2.668	82.3	1.000
18/20	0.0478	0.0359	4.8	1.376	1.332	2.301	1.651	1.362	1.394	1.689	1.314	2.661	82.1	1.000
18/18	0.0478	0.0478	5.3	1.532	1.474	2.536	1.984	1.395	1.278	1.818	1.312	2.661	82.1	1.000
18/16	0.0478	0.0598	5.8	1.689	1.616	2.736	2.315	1.421	1.182	1.926	1.301	2.661	82.1	1.000
16/18	0.0598	0.0478	6.1	1.757	1.699	2.950	2.135	1.709	1.382	1.726	1.318	2.653	81.9	0.994
16/16	0.0598	0.0598	6.6	1.914	1.841	3.188	2.469	1.743	1.291	1.829	1.316	2.653	81.9	0.994

GRADE 50: F <sub>y</sub> = 50 ksi, F <sub>u</sub> = 65 ksi														
Gage	I <sub>e+</sub> in <sup>4</sup> /ft	I <sub>e-</sub> in <sup>4</sup> /ft	I <sub>d+</sub> in <sup>4</sup> /ft	I <sub>d-</sub> in <sup>4</sup> /ft	S <sub>e+</sub> in <sup>3</sup> /ft	S <sub>e-</sub> in <sup>3</sup> /ft	M <sub>n+</sub> k-ft/ft	M <sub>n-</sub> k-ft/ft	M <sub>nx+</sub> k-ft/ft	M <sub>nx-</sub> k-ft/ft	V <sub>n</sub> k/ft	T <sub>n</sub> k/ft	V <sub>nn</sub> k/ft	V <sub>ni</sub> k/ft
20/20	1.491	1.294	1.626	1.495	0.519	0.706	2.163	2.942	6.246	4.371	6.418	55.40	1.350	2.608
20/18	1.633	1.550	1.784	1.728	0.516	0.909	2.150	3.788	7.629	4.471	6.418	62.45	1.253	1.930
18/20	1.984	1.606	2.090	1.838	0.798	0.852	3.325	3.550	6.879	5.675	11.339	66.60	1.477	3.111
18/18	2.172	1.889	2.293	2.105	0.819	1.055	3.413	4.396	8.267	5.813	11.339	73.70	2.054	3.370
18/16	2.330	2.210	2.465	2.385	0.836	1.318	3.483	5.492	9.646	5.921	11.339	80.80	1.936	2.719
16/18	2.704	2.214	2.786	2.459	1.111	1.199	4.629	4.996	8.896	7.121	14.136	84.95	2.198	3.798
16/16	2.914	2.567	3.005	2.774	1.134	1.475	4.725	6.146	10.288	7.263	14.136	92.05	2.851	4.158

R	w <sub>tf</sub>	w <sub>bf</sub>	w <sub>bp1</sub>	S <sub>bp</sub>
in.	in.	in.	in.	in.
0.188	4.946	1.446	8.000	6.000

d <sub>p</sub>	c <sub>p</sub>	P <sub>p</sub>
in.	in.	in.
0.156	0.433	5.569



# EVALUATION REPORT

Number: **2018**

Originally Issued: 07/11/2019

Revised: 01/04/2021

Valid Through: 07/31/2021

Page 53 of 54

Embossed Profiles

PLW2CD-36 AC FormLok,  
W2CD-36 AC FormLok

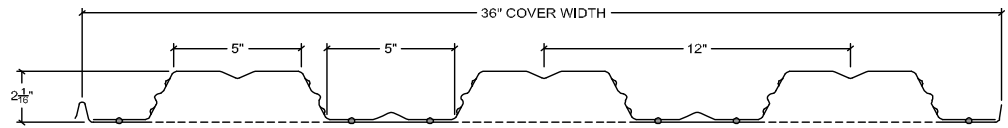

Gage	t in.	t <sub>b</sub> in.	w <sub>dd</sub> psf	A <sub>g</sub> in <sup>2</sup> /ft	A <sub>n</sub> in <sup>2</sup> /ft	I <sub>xg</sub> in <sup>4</sup> /ft	S <sub>xb</sub> in <sup>3</sup> /ft	S <sub>xt</sub> in <sup>3</sup> /ft	y <sub>b</sub> in.	y <sub>t</sub> in.	r in.	h <sub>w</sub> in.	θ deg.	K <sub>min</sub> -
20/20	0.0360	0.0359	3.4	0.957	0.920	0.676	1.037	0.456	0.652	1.482	0.857	2.047	63.6	1.000
20/18	0.0360	0.0478	3.8	1.108	1.060	0.726	1.245	0.464	0.583	1.564	0.828	2.047	63.6	1.000
18/20	0.0470	0.0359	3.9	1.109	1.073	0.831	1.143	0.586	0.727	1.419	0.880	2.044	63.5	1.000
18/18	0.0470	0.0478	4.3	1.261	1.212	0.893	1.355	0.596	0.659	1.499	0.858	2.044	63.5	1.000
18/16	0.0470	0.0598	4.8	1.413	1.353	0.946	1.561	0.605	0.606	1.564	0.836	2.044	63.5	1.000
16/18	0.0590	0.0478	4.9	1.427	1.379	1.066	1.472	0.737	0.724	1.446	0.879	2.041	63.3	0.854
16/16	0.0590	0.0598	5.4	1.580	1.519	1.130	1.682	0.749	0.672	1.509	0.863	2.041	63.3	0.854

GRADE 50: F <sub>y</sub> = 50 ksi, F <sub>u</sub> = 65 ksi														
Gage	I <sub>e+</sub> in <sup>4</sup> /ft	I <sub>e-</sub> in <sup>4</sup> /ft	I <sub>d+</sub> in <sup>4</sup> /ft	I <sub>d-</sub> in <sup>4</sup> /ft	S <sub>e+</sub> in <sup>3</sup> /ft	S <sub>e-</sub> in <sup>3</sup> /ft	M <sub>n+</sub> k-ft/ft	M <sub>n-</sub> k-ft/ft	M <sub>nxt+</sub> k-ft/ft	M <sub>nxt-</sub> k-ft/ft	V <sub>n</sub> k/ft	T <sub>n</sub> k/ft	V <sub>nn</sub> k/ft	V <sub>ni</sub> k/ft
20/20	0.641	0.459	0.653	0.531	0.363	0.420	1.513	1.750	4.321	1.900	3.911	46.00	0.974	1.824
20/18	0.687	0.507	0.700	0.580	0.370	0.439	1.542	1.829	5.188	1.933	3.911	53.00	0.904	1.105
18/20	0.829	0.578	0.830	0.662	0.524	0.539	2.183	2.246	4.763	2.442	5.158	53.65	1.064	2.314
18/18	0.892	0.629	0.892	0.717	0.534	0.561	2.225	2.338	5.646	2.483	5.158	60.60	1.436	1.984
18/16	0.944	0.690	0.945	0.775	0.542	0.579	2.258	2.413	6.504	2.521	5.158	67.65	1.349	1.512
16/18	1.064	0.761	1.065	0.863	0.700	0.690	2.917	2.875	6.133	3.071	6.455	68.95	1.544	2.416
16/16	1.128	0.824	1.129	0.926	0.711	0.712	2.963	2.967	7.008	3.121	6.455	75.95	2.004	2.410

Gage	A <sub>gtf</sub> in <sup>2</sup>	A <sub>stf</sub> in <sup>2</sup>	I <sub>sptf</sub> in <sup>4</sup>	A <sub>gbf</sub> in <sup>2</sup>	A <sub>sbf</sub> in <sup>2</sup>	I <sub>spbf</sub> in <sup>4</sup>
20/xx	0.177	0.043	0.001	0.177	0.043	0.001
18/xx	0.231	0.056	0.002	0.231	0.056	0.002
16/xx	0.289	0.071	0.002	0.289	0.071	0.002

b <sub>otf</sub> in.	b <sub>ptf</sub> in.	c <sub>stf</sub> in.	b <sub>obf</sub> in.	b <sub>pbf</sub> in.	c <sub>sbf</sub> in.
4.696	1.848	2.348	4.696	1.848	2.348

R in.	w <sub>bp1</sub> in.	w <sub>bp2</sub> in.	s <sub>bp</sub> in.
0.188	9.250	2.750	6.000

d <sub>p</sub> in.	c <sub>p</sub> in.	P <sub>p</sub> in.
0.156	0.433	6.868



# EVALUATION REPORT

Number: **2018**

Originally Issued: 07/11/2019

Revised: 01/04/2021

Valid Through: 07/31/2021

Page 54 of 54

Embossed Profiles

PLW3CD-36 AC FormLok,

W3CD-36 AC FormLok

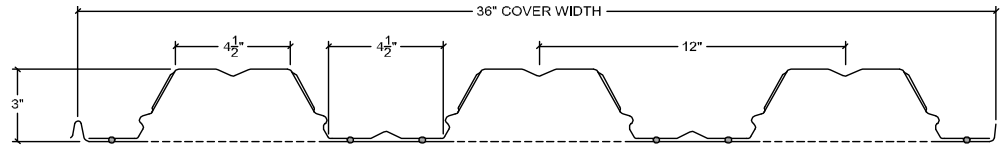

Gage	t in.	t <sub>b</sub> in.	w <sub>dd</sub> psf	A <sub>g</sub> in <sup>2</sup> /ft	A <sub>n</sub> in <sup>2</sup> /ft	I <sub>xg</sub> in <sup>4</sup> /ft	S <sub>xb</sub> in <sup>3</sup> /ft	S <sub>xt</sub> in <sup>3</sup> /ft	y <sub>b</sub> in.	y <sub>t</sub> in.	r in.	h <sub>w</sub> in.	θ deg.	K <sub>min</sub> -
20/20	0.0359	0.0359	3.6	1.002	0.965	1.426	1.511	0.670	0.944	2.128	1.216	3.112	63.1	0.000
20/18	0.0359	0.0478	4.0	1.153	1.105	1.531	1.820	0.683	0.841	2.242	1.177	3.112	63.1	0.000
18/20	0.0478	0.0359	4.1	1.182	1.146	1.777	1.683	0.876	1.056	2.028	1.245	3.108	63.0	0.000
18/18	0.0478	0.0478	4.6	1.334	1.285	1.910	1.996	0.893	0.957	2.139	1.219	3.108	63.0	0.000
18/16	0.0478	0.0598	5.0	1.486	1.426	2.021	2.302	0.906	0.878	2.230	1.190	3.108	63.0	0.000
16/18	0.0598	0.0478	5.2	1.515	1.467	2.268	2.168	1.100	1.046	2.062	1.243	3.105	62.9	0.000
16/16	0.0598	0.0598	5.7	1.668	1.608	2.403	2.480	1.117	0.969	2.151	1.222	3.105	62.9	0.000

GRADE 50: F <sub>y</sub> = 50 ksi, F <sub>u</sub> = 65 ksi														
Gage	I <sub>e+</sub> in <sup>4</sup> /ft	I <sub>e-</sub> in <sup>4</sup> /ft	I <sub>d+</sub> in <sup>4</sup> /ft	I <sub>d-</sub> in <sup>4</sup> /ft	S <sub>e+</sub> in <sup>3</sup> /ft	S <sub>e-</sub> in <sup>3</sup> /ft	M <sub>n+</sub> k-ft/ft	M <sub>n-</sub> k-ft/ft	M <sub>nx+</sub> k-ft/ft	M <sub>nx-</sub> k-ft/ft	V <sub>n</sub> k/ft	T <sub>n</sub> k/ft	V <sub>nn</sub> k/ft	V <sub>ni</sub> k/ft
20/20	1.424	0.973	1.425	1.124	0.542	0.608	2.258	2.533	6.296	2.792	3.776	48.25	1.379	2.879
20/18	1.527	1.073	1.528	1.226	0.542	0.640	2.258	2.667	7.583	2.846	3.776	55.25	1.267	1.628
18/20	1.775	1.249	1.776	1.425	0.847	0.794	3.529	3.308	7.013	3.650	6.858	57.30	1.525	3.937
18/18	1.908	1.353	1.909	1.539	0.863	0.830	3.596	3.458	8.317	3.721	6.858	64.25	2.097	3.146
18/16	2.020	1.478	2.020	1.659	0.860	0.862	3.583	3.592	9.592	3.775	6.858	71.30	1.961	2.250
16/18	2.266	1.633	2.267	1.845	1.099	1.018	4.579	4.242	9.033	4.583	9.918	73.35	2.264	3.804
16/16	2.401	1.761	2.402	1.975	1.116	1.057	4.650	4.404	10.333	4.654	9.918	80.40	2.910	3.587

Gage	A <sub>gtf</sub> in <sup>2</sup>	A <sub>stf</sub> in <sup>2</sup>	I <sub>sptf</sub> in <sup>4</sup>	A <sub>gbf</sub> in <sup>2</sup>	A <sub>sbf</sub> in <sup>2</sup>	I <sub>spbf</sub> in <sup>4</sup>
20/xx	0.159	0.043	0.001	0.159	0.043	0.001
18/xx	0.211	0.057	0.002	0.211	0.057	0.002
16/xx	0.263	0.072	0.002	0.263	0.072	0.002

b <sub>otf</sub> in.	b <sub>ptf</sub> in.	c <sub>stf</sub> in.	b <sub>obf</sub> in.	b <sub>pbf</sub> in.	c <sub>sbf</sub> in.
4.198	1.599	2.099	4.198	1.599	2.099

R in.	w <sub>bp1</sub> in.	w <sub>bp2</sub> in.	s <sub>bp</sub> in.
0.188	9.250	2.750	6.000

d <sub>p</sub> in.	c <sub>p</sub> in.	P <sub>p</sub> in.
0.156	0.433	6.868