



JOTO TECHNO CO., LTD JOTO-VENT FOUNDATION VENT SYSTEM

CSI Section: 09 30 00 - Sill Plate

1.0 RECOGNITION

The Joto-Vent System manufactured by Joto Techno Co., Ltd. has been evaluated for use to provide cross ventilation of the under-floor space below residential and commercial buildings.

The crawl space venting, vertical load support, fire characteristics, and termite resistance properties of the vent system were evaluated for compliance with the following codes:

- 2015, 2012 and 2009 International Building Code® (IBC)
- 2015, 2012 and 2009 International Residential Code® (2012 IRC)
- Supplement -- 2016 California Building Code (CBC)
- Supplement -- 2016 California Residential Code (CRC)

2.0 LIMITATIONS

The Joto-Vent System recognized in this report is subject to the following limitations:

2.1 The Joto-Vent System shall be installed in accordance with the code, the manufacturer’s published installation instructions, and this report. Where conflicts occur, the more restrictive shall govern.

2.2 The Joto-Vent System shall be installed only on concrete or concrete masonry perimeter stem wall foundations where a crawl space is present.

2.3 The Joto-Vent System prevents the sill plate from being in direct contact with concrete. The jurisdiction having authority shall make the final decision whether decay resistant lumber and or treated lumber shall be required.

2.4 Use of the Joto-Vent System with fire-retardant-treated wood is outside of the scope of this evaluation report.

2.5 The ventilation requirement shall conform to Sections 1203.4.1 and 1203.4.2 of the 2015 IBC (1203.3.1 and 1203.3.2 of the 2012 and 2009 IBC), or Sections R408.1, R408.2 and R408.3 of the IRC, as applicable.

2.6 Sill plates shall be in accordance with Section 2308.3.1 of the 2015 IBC (Section 2308.6 of the 2012 and 2009 IBC) or Section R403.1.6 of the IRC, as applicable.

3.0 PRODUCT USE INSTRUCTIONS

The system is used between the wood sill plate and the concrete or concrete masonry foundation to provide ventilation around the perimeter of Type V construction, see Details 7 and 11 of this report.

Refer to the manufacturer’s installation instructions for installation recommendations.

3.1 DESIGN: The required ventilation area shall be determined in accordance with Section 1203.4 of the 2015 IBC (1203.3 of the 2012 and 2009 IBC) or Section R408.1 of the IRC, as applicable. The required ventilation area shall be less than or equal to the Joto-Vent System effective ventilation area for use of the Joto-Vent System. The effective ventilation area for the Joto-Vent System is 4.81 in² per linear foot of Joto-Vent (102 cm²/m), regardless of the installation configuration.

Compression loads on sill plates installed over the Joto Vent are controlled by the allowable compression perpendicular to grain of the wood sill plate. Allowable compression perpendicular to grain shall be in accordance with Sections 3.10.2 and 4.2.6 of ANSI/AWC NDS-2015, including applicable adjustment factors for sawn lumber. Allowable anchor bolt shear loads shall be 385 lbs for 1/2-inch diameter (12.7 mm) and 575 lbs for 5/8-inch diameter (15.9 mm) anchor bolts respectively, multiplied by all applicable adjustment factors in accordance with the NDS. Sill plates shall be SPF species or better.

3.2 INSTALLATION: The installation of the Joto-Vent System shall comply with this report and the manufacturer’s installation instructions. Where there is a conflict between these documents, the most restrictive provisions shall govern.

The Joto-Vent System shall be installed between the top of the foundation wall and the bottom of the sill plate. Foundations shall be in accordance with Chapter 18 of the IBC or Chapter 4 of the IRC, as applicable. Steel anchor bolts shall be installed in accordance with Section 2308.3.1 of the 2015 IBC (Section 2308.6 of the 2012 and 2009 IBC) or Section R403.1.6 of the IRC, as applicable. The Joto-Vent shall be installed over the anchor bolts with a minimum of two bolts per foundation plate or sill with one anchor bolt located not more than 12 inches (305 mm) or less than 4 inches (102 mm) from each end. A properly sized nut and washer shall be installed on each bolt to hold the sill plate in accordance with Section 2308.3.1 of the 2015 IBC (Section 2308.6 of the 2012 and 2009 IBC), or Section R403.1.6 of the IRC, as applicable.

The Ventilation Covering shall be installed after the exterior wall sheathing is installed, but before installation

The product described in this Uniform Evaluation Service (UES) Report has been evaluated as an alternative material, design or method of construction in order to satisfy and comply with the intent of the provision of the code, as noted in this report, and for at least equivalence to that prescribed in the code in quality, strength, effectiveness, fire resistance, durability and safety, as applicable, in accordance with IBC Section 104.11. This document shall only be reproduced in its entirety.





of the exterior siding. If the Ventilation and Insect Prevention Flashing is required, it shall be installed prior to the installation of the Ventilation Covering. See Detail 10 for additional details. The Coverings shall be installed next to the foundation so that less than a 1/8 inch (3 mm) gap between the edge of the Covering and the foundation, see Details 8 and 10 of this report.

4.0 PRODUCT DESCRIPTION

4.1 General: The Joto-Vent System is composed of three parts: the Joto-Vent, which is placed between the foundation stem wall and the sill plate; the Ventilation Covering; and the optional VIP Ventilation and Insect Prevention Flashing.

4.2 Joto-Vent: The Joto-Vent is a composite material of calcium carbonate, plastic and polyolefin resin molded into the specified shapes as shown in Detail 1. The Joto-Vent is nominally 3/4 inches (20 mm) thick and has a unique honeycomb cross-section with nominal 1/4-inch (6.3 mm) minimum net openings. Two sizes are available, identified as KP-L102U for 2 x 4 framing and KP-L150U for 2 x 6 and 2 x 8 framing. The net ventilation area is 4.81 in² per linear foot (102 cm²/m) for both the KP-L150U and KPL102U.

4.3 Architectural Covering: The Architectural Covering (WMF-U35 and WMF-U55, see Detail 2 of this report and WACF-U45, see Details 3 and 8 of this report) are made from nominal 28 gauge [0.0138 inch (0.35 mm)] galvanized sheet steel complying with ASTM A792 (JIS G 3322). The Premium Covering (WPCA-U45, see Details 4 and 9 of this report) is an extruded aluminum covering made from 0.0472 inch (1.2 mm) thick aluminum complying with ANSI-H35.1. The coverings are used with the Joto-Vent and provide flashing to shed water at the base of exterior siding or cladding. See Details 2, 3 and 4 for specific details and dimensions of the covering. The coverings are used in all cases with the Joto-Vent.

4.4 Ventilation and Insect Prevention Flashing (VIP): The Ventilation and Insect Prevention Flashing (VIP-U0609-L30) is used where the building code requires a minimum ventilation dimension of 1/8-inch (3.2 mm). This flashing is used as an attachment along with the Ventilation Covering described in Section 4.3. See Detail 5 for specific details and dimensions. VIP flashing is made from galvanized sheet steel complying with ASTM A792 (JIS G 3322). The VIP flashing has 1/8-inch (3.2 mm) nominally net openings.

4.5 Accessories:

4.5.1 Air Blocking: KPA-L102U and KPA-L150U (see Detail 6 of this report) are EPP inserts placed on one edge of the Joto-Vent to prevent air flow through the vent between the living space and the garage. The EPP Air Block material has a flame spread index of less than 25 and a

smoke-developed index of less than 450 when tested in accordance with ASTM E84. The Air Blocking shall be separated from the interior of the building by a thermal barrier in accordance with Section 2603.4 of the IBC or Section R316.4 of the IRC, as applicable (see Details 12 and 13 of this report). In areas where the probability of termite infestation is very heavy Air Block shall be protected against termites in accordance with Section 2603.8 of the 2015 IBC (Section 2603.9 of the 2012 and 2009 IBC) or Section R316.7 of the IRC, as applicable.

4.5.2 Vertical Covering – Coverings used on stepped foundations when required on sloped terrain. Vertical coverings come in both Architectural Series (WACF-U45VC) and Premium Series (WPCA-U45VC).

4.5.3 – Dent Covers – Used to cover dents or scratches that occur after the covering is installed. Dent covers are available in Architectural Series (WCF-45).

5.0 IDENTIFICATION

Each piece of Joto-Vent is stamped on one end with the lot number. Packages of the Joto-Vent System are labeled with the following information: the words “Joto-Vent System”; the company name, Joto Techno Co., Ltd; the product name; color; lot number, the words “Made in Japan”; the number of pieces in the package, the UES report number (ER-346); and the name of the inspection agency, RI Ogawa & Associates, Inc. (AA 705).

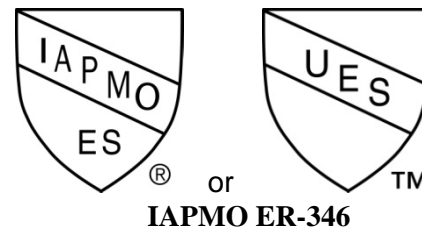

6.0 SUBSTANTIATING DATA

6.1 Manufacturer’s installation instructions and product descriptive literature. Test reports are from laboratories in compliance with ISO/IEC 17025. Reports of self-ignition temperature testing in accordance with ASTM D1929.

6.2 Reports of combustibility classification testing in accordance with ASTM D635.

6.3 Reports of Surface Burning Characteristics testing in accordance with ASTM E84.

6.4 Reports of vertical (compression) and horizontal (shear) load testing.

6.5 Documentation describing the manufacturer’s quality management system.



7.0 CONTACT INFORMATION

Joto Techno Co., Ltd

3-14-1 Shodai Tajika
Hirakata, Osaka, Japan
Tel: +81 72 868 6611
www.joto.com

8.0 STATEMENT OF RECOGNITION:

This report describes the results of research carried out by the IAPMO Uniform Evaluation Service on The Joto-Vent System manufactured by Joto Techno Co., Ltd. in Japan to assess its conformance to the codes listed in Section 1.0, and serves as documentation of the product certification.

Brian Gerber, P.E., S.E.
Vice President, Technical Operations
Uniform Evaluation Service

Richard Beck, PE, CBO, MCP
Vice President, Uniform Evaluation Service

GP Russ Chaney
CEO, The IAPMO Group

For additional information about this evaluation report please visit
www.uniform-es.org or email at info@uniform-es.org



DETAIL #1

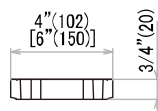
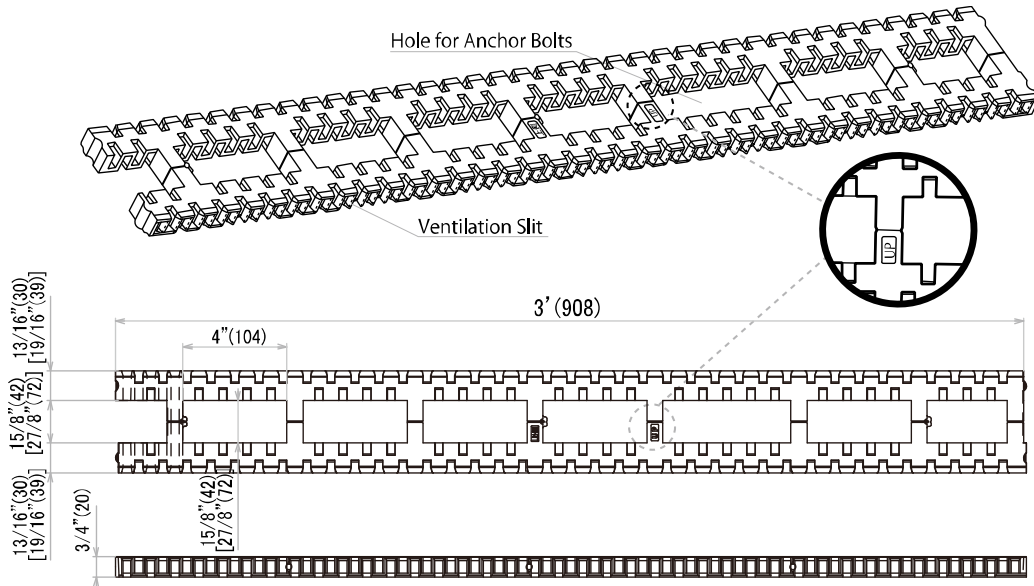

Product Name : **Joto-Vent**

KP-L102U, []: KP-L150U

Net Ventilation Area : **4.81** in²/ft (102 cm²/m)

DETAIL #2

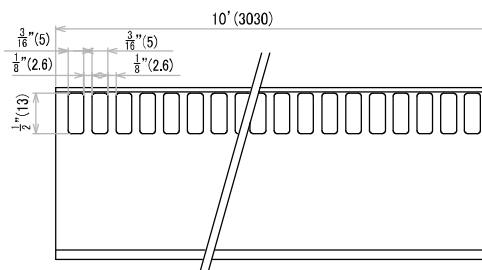
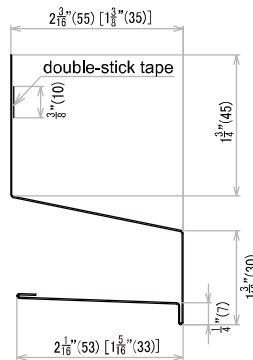

Product Name : **Architectural Covering**

WMF-U55, []: WMF-U35

DETAIL #3

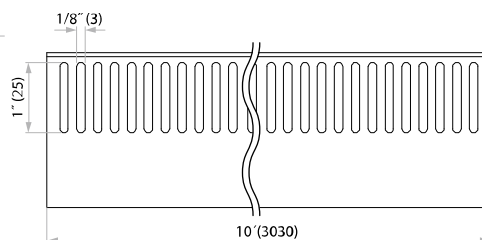
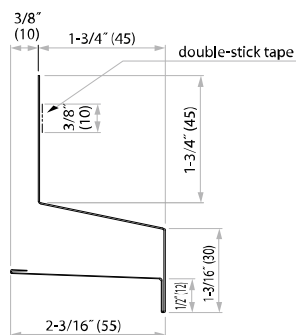

Product Name : **Architectural Covering**
WACF-U45



DETAIL #4

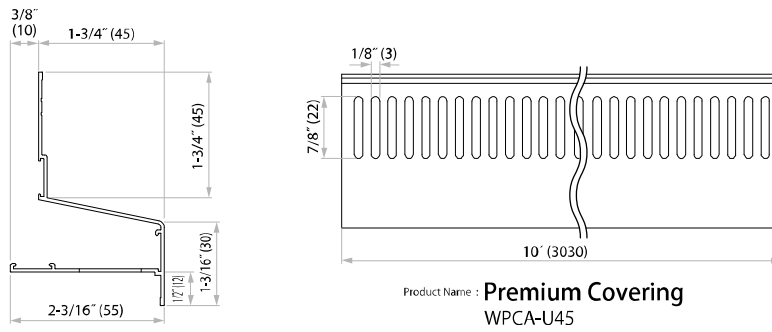

DETAIL #5

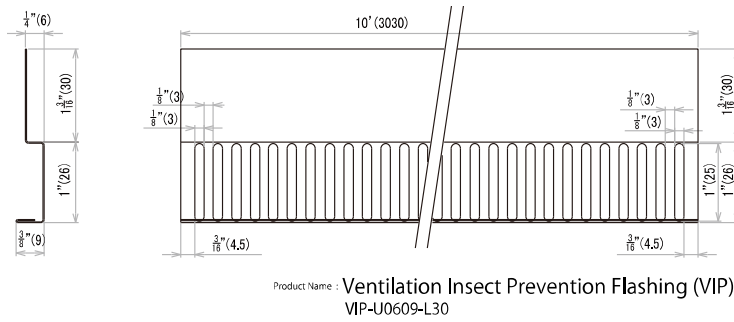

DETAIL #6

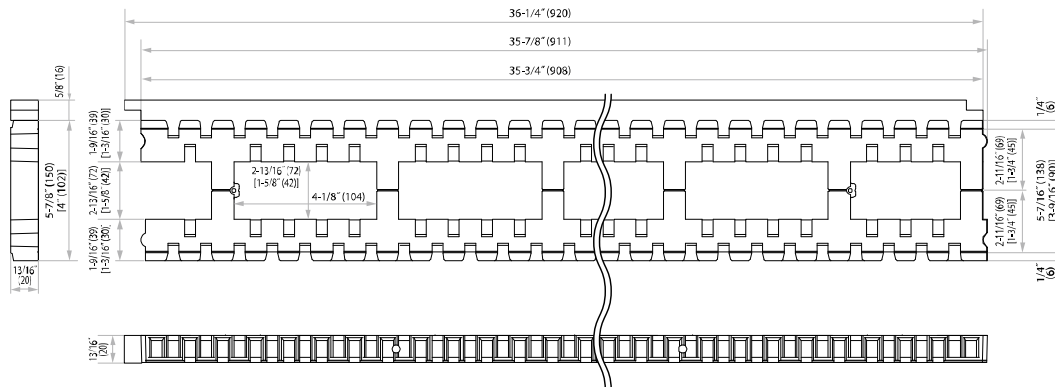

Product Name : Joto-Vent Air-blocking

The dimensions in bracket "[]" are of KPA-L102U.



DETAIL #7

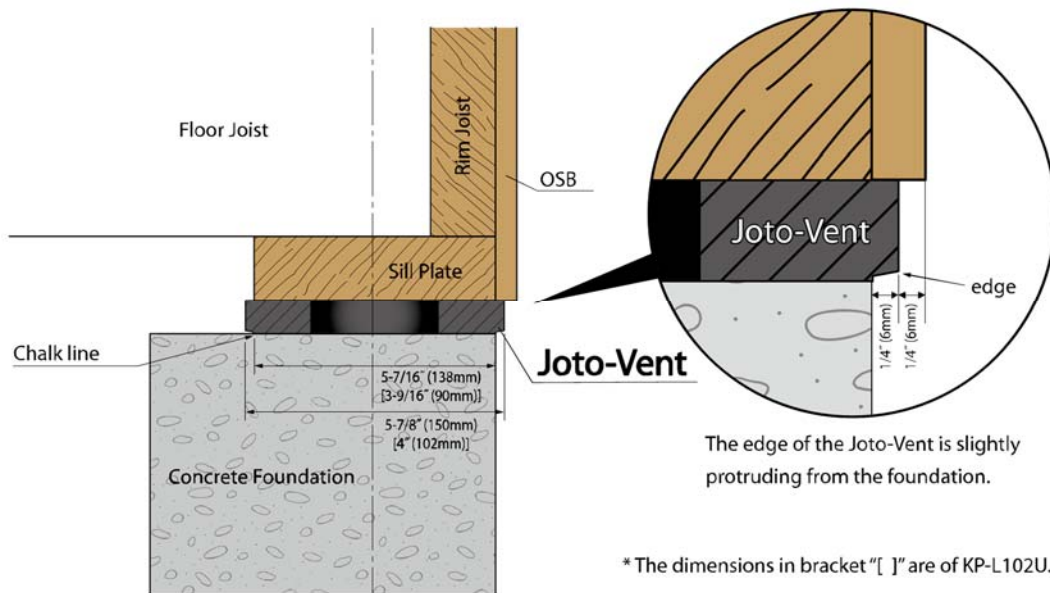

DETAIL #8

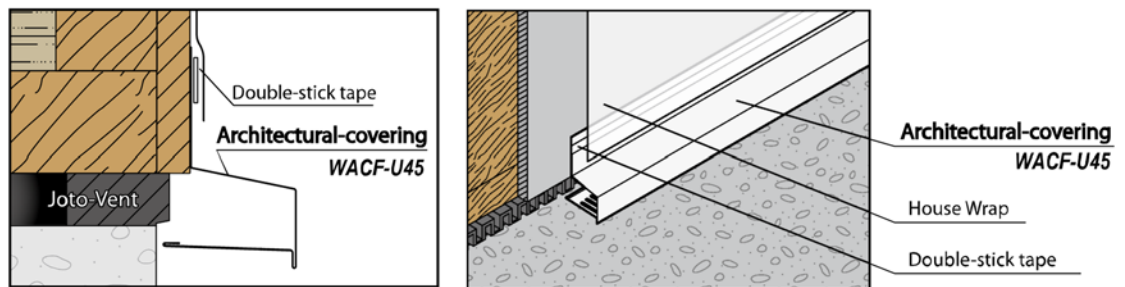

DETAIL #9

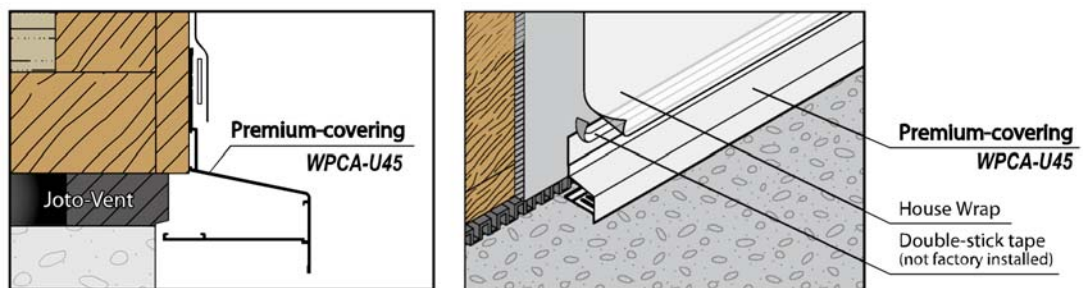



DETAIL #10

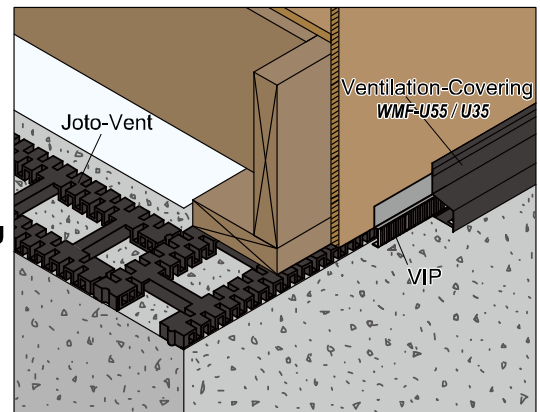
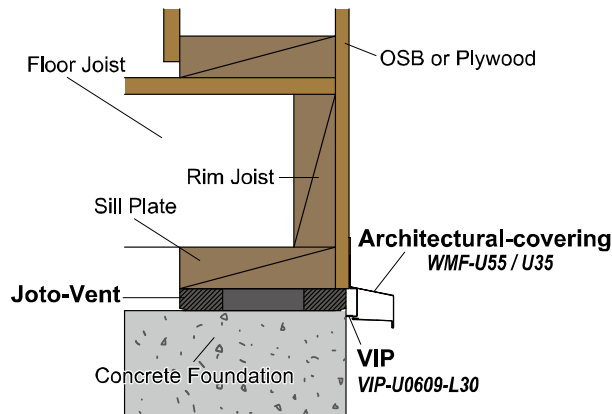
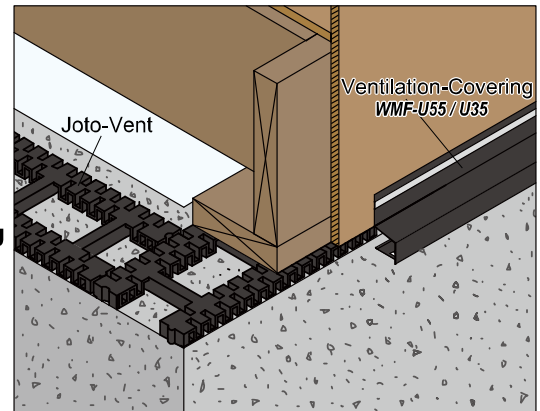
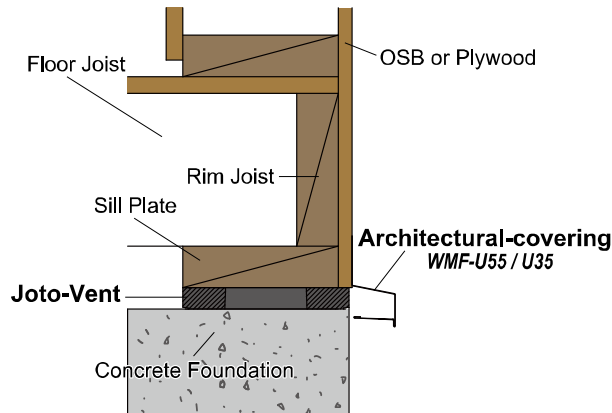

DETAIL #11

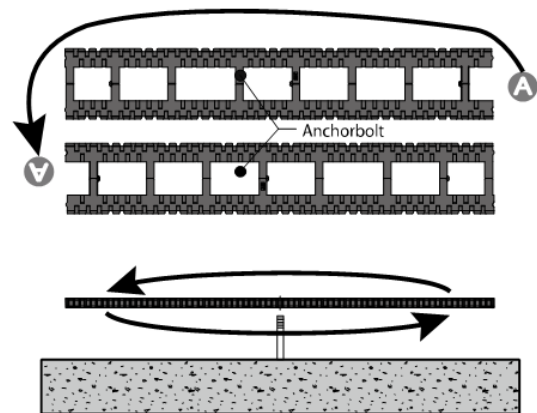
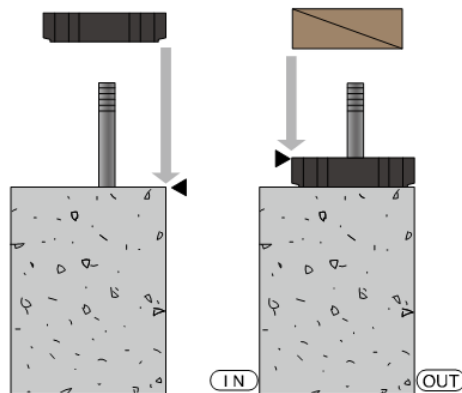

DETAIL #12

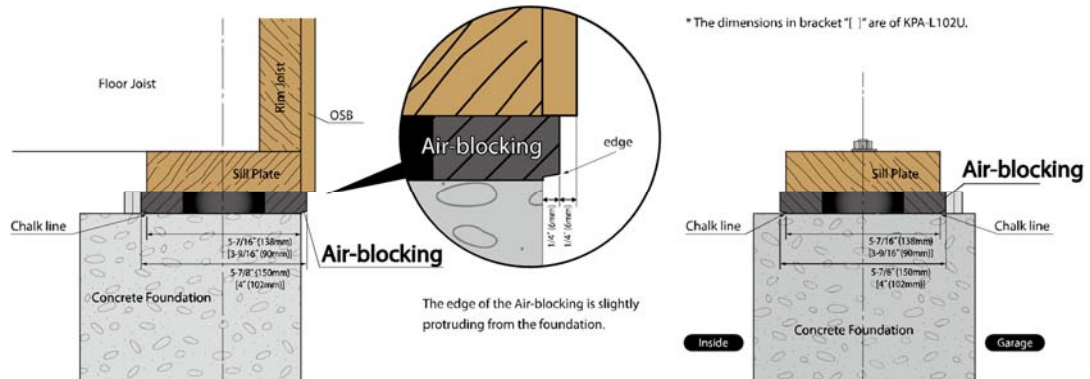

DETAIL #13

- (1) Foundation that requires no ventilation
(stepped foundation: above the floor level)

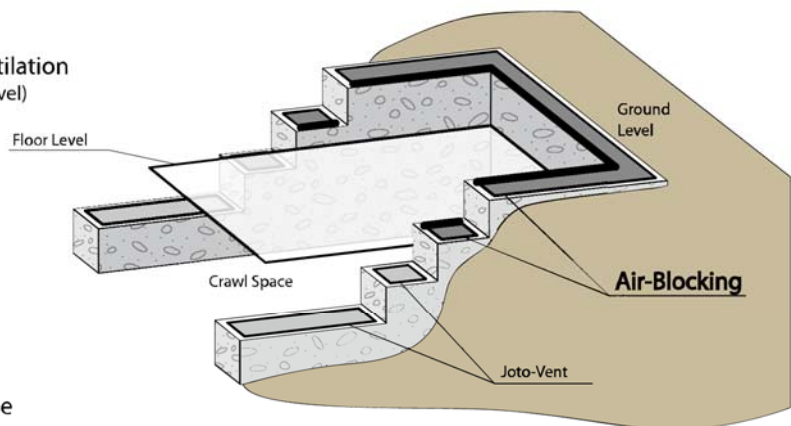

- (2) Foundation surrounding a garage

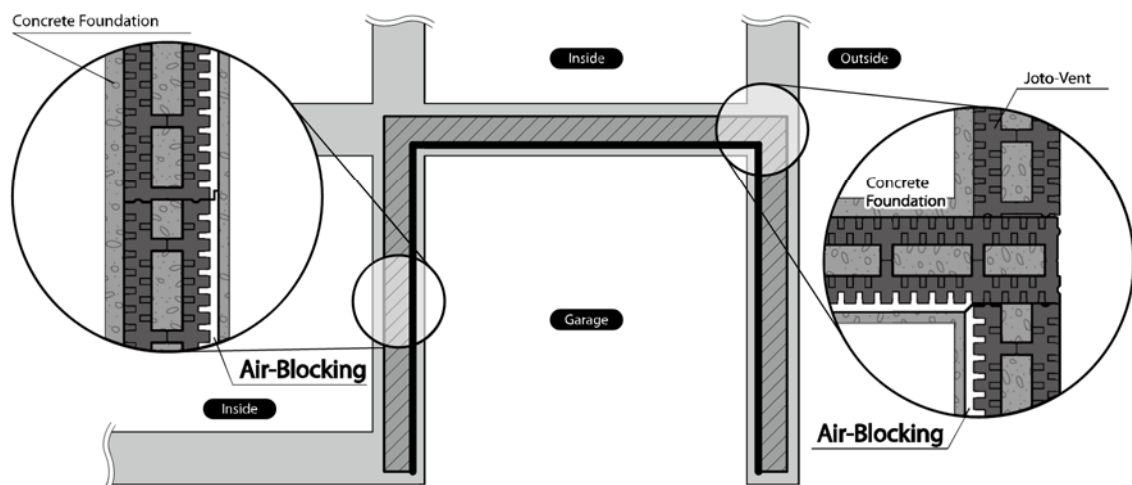



CALIFORNIA SUPPLEMENT

EVALUATION SUBJECT: JOTO-VENT FOUNDATION VENT SYSTEM

REPORT HOLDER:
Joto Techno Co., Ltd
3-14-1 Shodai Tajika
Hirakata, Osaka, Japan
Tel: +81 72 868 6611
www.joto.com

CSI Division: 09 - FOUNDATION
CSI Section: 09 30 00 - Sill Plate

1.0 SCOPE OF EVALUATION

1.1 Compliance to the following codes & regulations:

- 2016 California Building Code® (CBC)
- 2016 California Residential Code® (CRC)

1.2 Evaluated in accordance with:

- CBC Section 1203.4 and CRC Sections R408.1 and R408.2
- CBC Sections 2308.3.1 and 2308.5.3 and CRC Section R403.1.6
- CBC Section 2606.4

1.3 Properties assessed:

- Crawl Space Venting
- Vertical load support
- Fire Characteristics

2.0 FINDINGS:

The Joto-Vent System with Ventilation Covering may be used in the construction of new buildings located within a Wildland-Urban Interface Fire Area provided installation is in accordance with ER-346 and the additional requirements of Section 706A.2, item 2 of the CBC.

The Joto-Vent System described in ER-346 complies with the California Building Code (CBC) and California Residential Code (CRC). Design, installation, and identification shall comply with ER-346.

3.0 LIMITATIONS

The Joto-Vent System described in this report, comply with the codes listed in Section 1.0 of this supplement, subject to the limitations in Section 5.0 of ER-346.

For additional information about this evaluation report please visit www.uniform-es.org or email at info@uniform-es.org