



EVALUATION SUBJECT: SIMPSON STRONG-DRIVE® SDW22, SDWS22DB, SDWH19DB, SDWS22, SDWS19, SDWH27G, and SDWS16 WOOD SCREWS

REPORT HOLDER:

Simpson Strong-Tie Company Inc.
5956 West Las Positas Boulevard
Pleasanton, California 94588
(800) 999-5099
www.strongtie.com

CSI Division: 06 – WOOD, PLASTICS, AND COMPOSITES
CSI Section: 06 05 23 – Wood, Plastic, and Composite Fastenings

1.0 SCOPE EVALUATION SCOPE

1.1 Compliance with the following codes:

- 2015, 2012 and 2009 International Building Code® (IBC)
- 2015, 2012 and 2009 International Residential Code® (IRC)

1.2 Evaluated in accordance with:

- ICC-ES AC233, approved April 2015, editorially revised August 2015
- ICC-ES AC257, approved October 2009 (editorially revised May 2015)

1.3 Properties assessed:

- Structural
- Corrosion Resistance

2.0 PRODUCT USE

Simpson Strong-Drive® SDW TRUSS-PLY and SDW EWP-PLY Screws (SDW22), SDWS TIMBER Screws (SDWS22DB), SDWH TIMBER-HEX Screws (SDWH19DB), SDWS LOG Screws (SDWS22), SDWS19, SDWH TIMBER-HEX HDG Screws (SDWH27G), and SDWS FRAMING Screws (SDWS16) described in this report are dowel-type threaded and self-drilling fasteners used for wood-to-wood and steel-to-wood connections.

The Simpson Strong-Drive SDW22, SDWS22DB, SDWH19DB, SDWS22, SDWS19, and SDWS16 wood screws have proprietary corrosion-resistant coatings and may be used where fasteners are required to exhibit corrosion resistance when exposed to adverse environmental conditions and/or in chemically-treated wood, which are subject to limitations of Section 5.3 of this report, and are alternatives to hot-dipped, zinc-coated, galvanized fasteners with a coating weight in compliance

with [ASTM A153](#), Class D. Screws with these proprietary corrosion-resistance coatings were evaluated for contact with wood chemically treated with waterborne alkaline copper quaternary, Type D (ACQ-D), to a maximum retention level of 0.40 pcf (6.4 kg/m³), which was shown to be more corrosive than Chromated Copper Arsenate, Type C (CCA-C), Micronized Copper Azole (MCA), and Dispersed Copper Azole (μCA-C). The SDWH27G wood screws are coated with a hot-dipped, zinc-coated, galvanized finish in accordance with ASTM A153, Class C.

3.0 PRODUCT DESCRIPTION

3.1 General: The SDW22, SDWS22DB, SDWH19DB, SDWS22, SDWS19, SDWH27G, and SDWS16 wood screws are manufactured using a standard cold-forming process and consist of heat-treated carbon steel. The SDW22, SDWS22DB and SDWS22 screws have rolled threads, spaced approximately 5 threads per inch and a flat head with a T-40 recess. The SDWH19DB and SDWS19 screws have rolled threads spaced approximately 6 threads per inch. The SDWH19DB screws have a ⁵/₁₆ inch hex head with an integral washer. The SDWS19 screws have a flat head with a T-40 recess. The SDWH27G screws have rolled threads, spaced approximately 5 threads per inch and a ³/₈-inch hex head with an integral washer. The SDWS16 screws have rolled threads spaced approximately 9 threads per inch and a flat head with a T-25 recess. All screws have serrated threads and a proprietary point. The SDW22 screws have 8 screw lengths ranging from 2¹⁵/₁₆ inches to 6³/₄ inches with thread lengths ranging from 1⁷/₁₆ to 1⁹/₁₆ inches. The SDWS22DB screws have 8 screw lengths ranging from 3 to 10 inches with thread lengths ranging from 1¹/₂ to 2³/₄ inches. The SDWH19DB screws have 5 screw lengths ranging from 3 to 10 inches with thread lengths ranging from 1¹/₂ to 2³/₄ inches. The SDWS22 screws have 6 screw lengths ranging from 8 to 15 inches with thread lengths of 2³/₄ inches. The SDWS19 screws have 2 screw lengths of 6 and 7¹/₂ inches with thread lengths of 2³/₄ inches. The SDWH27G screws have 5 screw lengths ranging from 4 to 12 inches with thread lengths of 3 inches. The screws have a proprietary coating except for the SDWH27G screws, which have a hot-dipped, galvanized coating in accordance with ASTM A153, Class C. The SDWS16 screws have 2 screw lengths of nominally 2¹/₂ and 3 inches with thread lengths of 1¹/₈ and 1⁵/₈ inches, respectively. [Table 1](#) of this report provides a description of the screws recognized in this report, and specifies the allowable bending yield strengths as well as allowable tensile and shear loads.

3.2 Materials

3.2.1 SDW22, SDWS22DB, SDWH19DB, SDWS22, SDWS19, SDWH27G, and SDWS16 Wood Screws:

The SDW22, SDWS22DB, SDWH19DB, SDWS22, SDWS19, SDWH27G, and SDWS16 wood screws are manufactured from C10B21 carbon steel wire complying with [ASTM A510](#).

The product described in this Uniform Evaluation Service (UES) Report has been evaluated as an alternative material, design or method of construction in order to satisfy and comply with the intent of the provision of the code, as noted in this report, and for at least equivalence to that prescribed in the code in quality, strength, effectiveness, fire resistance, durability and safety, as applicable, in accordance with IBC Section 104.11. This document shall only be reproduced in its entirety.





3.2.2 Wood Members: Wood side and main members shall consist of sawn lumber species or species combinations with a specific gravity of 0.42 to 0.55 or structural composite lumber (e.g. LVL, PSL and LSL) having a minimum 0.8E designation for lateral and withdrawal loading. The structural composite lumber shall be recognized in evaluation reports and shall have an equivalent specific gravity of 0.50 minimum for lateral and 0.42 for withdrawal loading. [Tables 2, 3, 5, 6, 7, 9, 10, 11, 13, 14, 15, 17, 18, 19, 21, and 22](#) of this report include design values. Wood side members shall be as specified in those tables.

Chemicals used for preservative treat wood are limited to the following:

1. Alkaline Copper Quaternary Type D (ACQ-D), with a maximum retention level of 0.4 pcf (6.4 kg/m³)
2. Wood treatments that have been demonstrated to have lower levels of corrosivity compared to ACQ-D.

3.2.3 Steel Member: Steel side members shall have minimum tensile strength, F_u , equal to 45 ksi with a steel member design thickness (base-metal thickness exclusive of any coatings) of 0.0966 inch for No.12 gage steel. The hole in the steel side member for the SDWS22312DBB and SDWS22512DBB shall be predrilled or pre-punched, and shall have a standard round hole diameter no greater than 0.5625 inch when used with STN22.

4.0 DESIGN AND INSTALLATION

4.1 Design

4.1.1 General: Reference lateral and withdrawal design values in the report are for allowable stress design, and shall be multiplied by all applicable adjustment factors specified in the ANSI/AWC NDS (NDS) to determine adjusted design values, including wet service condition specified in Section 11.3.3 of the ANSI/AWC NDS - 2015 (Section 10.3.3 of the ANSI/AWC [NDS -2012](#) and ANSI/AF&PA NDS – 2005). Local stresses in connections using multiple fasteners shall be checked in accordance with Section 11.1.2 and Appendix E of ANSI/AWC NDS – 2015 (Section 10.1.2 and Appendix E of the ANSI/AWC NDS – 2012 and ANSI/AF&PA NDS – 2005) . Structural members forming the connection shall be designed in accordance with the IBC or IRC.

SDW, SDWS and SDWH wood screws have corrosion-resistant coatings that are recognized for use in wood members with chemical treatments as set forth in Section 3.2.2. These fasteners shall be limited to use in applications and limitations defined in [Table 24](#) of this report. SDWH27G screws conform to the coating requirements of Section [2304.9.5](#) of the 2012 and 2009 IBC.

4.1.2 Lateral Design Values: Reference lateral (Z) design values for SDW22, SDWS22DB, SDWH19DB, SDWS22,

SDWS19, SDWH27G, and SDWS16 series wood screws for single shear wood-to-wood connections loaded perpendicular and parallel to grain are shown in [Tables 2, 5, 6, 9, 10, 13, 14, 17, 18, 21, and 24](#) of this report. Minimum connection geometries shall comply with [Tables 4, 8, 12, 16, 20, 23, and 26](#) of this report, as applicable.

4.1.3 Reference Withdrawal Design Values: Reference withdrawal (W) design values for SDW22, SDWS22DB, SDWH19DB, SDWS22, SDWS19, SDWH27G, and SDWS16 wood screws are shown in [Tables 3, 7, 11, 15, 19, 22, and 25](#) of this report, respectively. Edge distance, end distance and spacing requirements for screws loaded in withdrawal and not loaded laterally are shown in Table 28 of this report. Loads are given in pounds per inch of thread penetration into the main member and maximum withdrawal load.

4.1.4 Pull-through Design Values: Pull-through design values are incorporated into the reference withdrawal design tables shown in [Tables 3, 7, 11, 15, 19, 22, and 25](#) of this report.

4.1.5 Framing Connections: The SDWS16 screws may be used for framing connections as given in the nail fastening schedules of [Table R602.3](#) (1) of the IRC and Table 2304.10.1 of the 2015 IBC ([Table 2304.9.1](#) of the 2009 and 2012 IBC), as applicable. For conventional construction, the SDWS16212 is an alternative to 8d common nails and 10d common nails, and the SDWS16300 is an alternative to 10d common and 16d common nails.

4.2 Installation: The SDW22, SDWS22DB, SDWH19DB, SDWS22, SDWS19, SDWH27G, SDWS16 wood screws shall be installed in accordance with the manufacturer's installation instruction, the evaluation report and the codes listed in Section 1, using a low speed drill. Installation may be performed without predrilling wood members with pilot holes. Edge distances, end distances and spacing of the screws shall be sufficient to prevent splitting of the wood, or as required by [Tables 4, 8, 12, 16, 20, 23, and 26](#) of this report, whichever is more restrictive. The bottom of the screw head shall be installed flush to the surface of the member being connected.

4.2.1 STN22: The SDWS22312DBB and SDWS22512DBB may be used in conjunction with the STN22 Hex-Head Washer, which has a proprietary black corrosion-resistant coating referenced in Section 2.0 of the report. The STN22 is manufactured using a standard cold-forming process from low-carbon steel, Grade AISI 1008 to 1022. When installing SDWS22312DBB and SDWS22512DBB, the STN22 shall be placed onto wood or steel side plate member prior to screw installation. Reference lateral (Z) design values for SDWS22312DBB and SDWS22512DBB wood screws when used with the STN22 are shown in [Table 6A of this report](#). [Figure 7 of this report](#) illustrates the STN22 Hex-Head Washer.



Originally Issued: 08/03/2010

Revised: 02/23/2018

Valid Through: 02/28/2019

5.0 LIMITATIONS

The Simpson Strong-Drive® SDW22, SDWS22DB, SDWH19DB, SDWS22, SDWS19, SDWH27G, and SDWS16 wood screws described in this report comply with, or are suitable alternatives to what is specified in, those codes listed in Section 1.0 of this report, subject to the following limitations:

5.1 When designing a connection, the connection shall be analyzed for conformance to Sections 11.1.2, 11.2.2 and 12.6 of ANSI/AWC NDS - 2015 (Section 10.1.2, 10.2.2, and 11.6 of the ANSI/AWC NDS – 2012 and ANSI/AF&PA NDS – 2005) to ensure the capacity of the connection and fastener group.

5.2 Where the screws are subjected to combined lateral and withdrawal loads, connections shall be designed in accordance with Section 12.4.1 of ANSI/AWC NDS - 2015 (Section 11.4.1 of the ANSI/AWC NDS– 2012 and ANSI/AF&PA NDS – 2005).

5.3 Use of fasteners in locations exposed to saltwater or saltwater spray is outside the scope of this evaluation report for all screws except the SDWH27G screws.

5.4 The SDW22, SDWS22DB, SDWH19DB, SDWS22, SDWS19, SDWH27G, and SDWS16 wood screws are manufactured under a quality control program with inspections by IAPMO UES.

6.0 SUBSTANTIATING DATA

6.1 Data and test reports submitted are from laboratories in compliance with [ISO/IEC 17025](#) and in accordance with the ICC-ES Acceptance Criteria for Alternate Dowel-type Threaded Fasteners (AC233), approved April 2015, editorially revised August 2015.

6.2 Data in accordance with the ICC-ES Acceptance Criteria for Corrosion-Resistant Fasteners and Evaluation of Corrosion Effects of Wood Treatment Chemicals (AC 257), approved October 2009 (editorially revised May 2015).

7.0 IDENTIFICATION

The packaging for the SDW22, SDWS22DB, SDWH19DB, SDWS22, SDWS19, SDWH27G, and SDWS16 wood screws are labeled with designations: “Simpson Strong-Drive® SDW22”, “Simpson Strong-Drive® SDWS22DB”, “Simpson Strong-Drive® SDWH19DB”, “Simpson Strong-Drive® SDWS22”, “Simpson Strong-Drive® SDWS19”, “Simpson Strong-Drive® SDWH27G”, and “Simpson Strong-Drive® SDWS16”, respectively, the Simpson Strong-Tie name and address, the fastener size, and the IAPMO UES evaluation report number (ER-192). Each screw head is marked with the No-Equal symbol (≠) and the alpha-numeric letters “W22”, “WS22”, “19”, “27”, or “WS16” indicating diameter and followed by a number designating screw length, as shown in [Table 1 of this report](#).

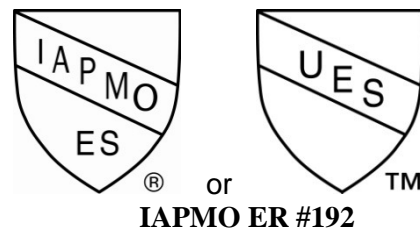

Brian Gerber

Brian Gerber, P.E., S.E.
Vice President, Technical Operations
Uniform Evaluation Service

Richard Beck

Richard Beck, PE, CBO, MCP
Vice President, Uniform Evaluation Service

Russ Chaney

GP Russ Chaney
CEO, The IAPMO Group

For additional information about this evaluation report please visit www.uniform-es.org or email at info@uniform-es.org



Originally Issued: 08/03/2010

Revised: 02/23/2018

Valid Through: 02/28/2019

TABLE 1 – SDW22, SDWS22DB, SDWH19DB, SDWS22, SDWS19, SDWH27G. AND SDWS16 WOOD SCREW SPECIFICATIONS, ALLOWABLE BENDING YIELD STRENGTH, AND FASTENER ALLOWABLE STEEL STRENGTH

FASTENER DESIGNATION	HEAD MARKING #.##	SCREW LENGTH ¹ L (in.)	THREAD LENGTH ² TL (in.)	UNTHREADED SHANK DIAMETER (in.)	MAJOR THREAD DIAMETER (in.)	MINOR THREAD (ROOT) DIAMETER (in.)	FASTENER ALLOWABLE STEEL STRENGTH ⁴		
							Bending Yield Strength ³ (F _{yb}) (psi)	Tension (lbf)	Shear (lbf)
SDW22300	3.00	2.940	1 7/16	0.219	0.305	0.198	180,000	1,550	1,125
SDW22338	3.37	3.340	1 9/16						
SDW22438	4.37	4.375	1 7/16						
SDW22458	4.62	4.585	1 7/16						
SDW22500	5.00	5.040	1 9/16						
SDW22600	6.00	5.940	1 7/16						
SDW22638	6.37	6.315	1 7/16						
SDW22634	6.75	6.740	1 9/16						
SDWS22300DB	3	3	1 1/2	0.219	0.305	0.198	160,000	1,505	910
SDWS22312DBB	3.5	3.5	2						
SDWS22400DB	4	4	2 3/8						
SDWS22500DB	5	5	2 3/4						
SDWS22512DBB	5.5	5.5	2 3/4						
SDWS22600DB	6	6	2 3/4						
SDWS22800DB	8	8	2 3/4						
SDWS221000DB	10	10	2 3/4						
SDWH19300DB	3	3	1 1/2	0.197	0.268	0.177	165,000	1,210	770
SDWH19400DB	4	4	2 3/8						
SDWH19600DB	6	6	2 3/4						
SDWH19800DB	8	8	2 3/4						
SDWH191000DB	10	10	2 3/4						
SDWS22800	8	8	2 3/4	0.219	0.305	0.198	175,000	1,575	1,055
SDWS22900	9	9	2 3/4						
SDWS221000	10	10	2 3/4						
SDWS221100	11	11	2 3/4						
SDWS221200	12	12	2 3/4						
SDWS221500	15	15	2 3/4						
SDWS19600	6	6	2 3/4	0.197	0.268	0.177	175,000	1,245	780
SDWS19712	7.5	7.5	2 3/4						
SDWH27400G	4	4	3	0.272	0.386	0.235	146,000	2,050	1,465
SDWH27600G	6	6	3						
SDWH27800G	8	8	3						
SDWH271000G	10	10	3						
SDWH271200G	12	12	3						
SDWS16212	2.5	2.40	1 1/8	0.156	0.212	0.140	185,000	1,015	605
SDWS16300	3	2.90	1 5/8						

For SI: 1 inch = 25.4 mm, 1 psi = 6.89 kPa, 1lbf = 4.45 N

- For purposes of measuring overall fastener length, fasteners shall be measured from the underside of head to bottom of the point.
- Thread length includes the point, as shown in [Figure 1](#) of this report.
- Bending yield strength determined per methods specified in [ASTM F1575](#) and based on the minor thread (root) diameter.
- Allowable fastener loads are based on steel properties of the screw. Refer to subsequent tables for allowable reference lateral (Z) and withdrawal (W) design values for using the screws in wood-to-wood connections.

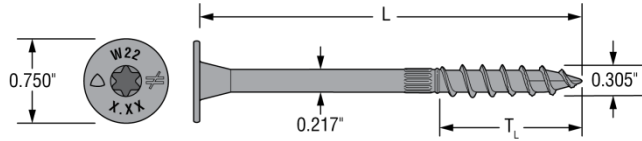

FIGURE 1 – SDW22 SCREWS
U.S. Patents 5,897,280;
7,101,133 and 6,109,850

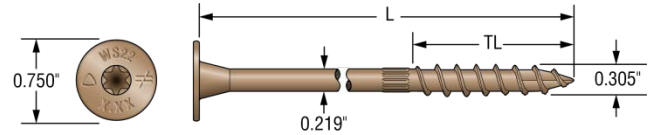

FIGURE 2 – SDWS22DB SCREWS
(SDWS22 SCREWS similar)
U.S. Patents 5,897,280; 7,101,133

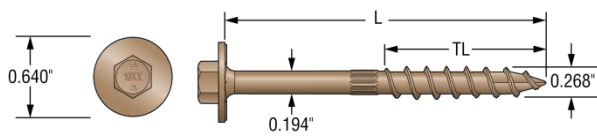

FIGURE 3 – SDWH19DB SCREWS

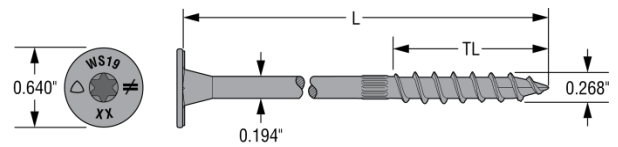

FIGURE 4 – SDWS19 SCREWS

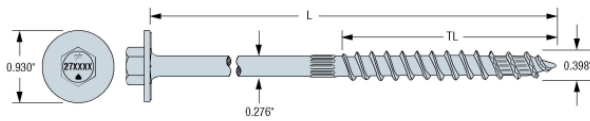

FIGURE 5 – SDWH27G SCREWS

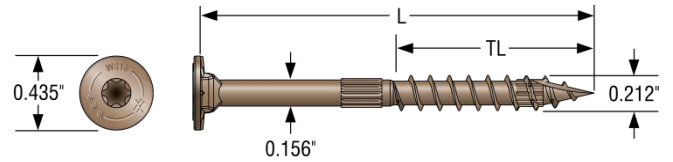

FIGURE 6 – SDWS16 SCREWS

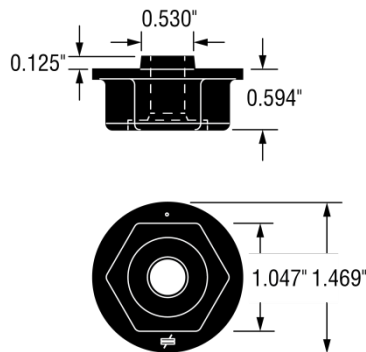

FIGURE 7 – STN22 HEX-HEAD WASHER



Originally Issued: 08/03/2010

Revised: 02/23/2018

Valid Through: 02/28/2019

TABLE 2 – REFERENCE LATERAL (Z) DESIGN VALUES FOR WOOD-TO-WOOD CONNECTIONS WITH SDW22 WOOD SCREWS^{1,2,3,4,5}

MODEL	SIDE MEMBER THICKNESS (in.)	MAIN MEMBER PENETRATION (in.)	ALLOWABLE SHEAR LOADS (lbf)	
			DF/ SP Members	HF/SPF Members
SDW22300	1 ½	1 3/8	325	255
SDW22338	1 ¾	1 5/8	400	255
SDW22438	1 ½	2 7/8	400	325
SDW22458	1 ½	2 7/8	400	325
SDW22500	1 ¾	3 1/4	400	325
SDW22600	1 ½	4 1/2	400	340
SDW22638	1 ½	4 1/2	400	340
SDW22634	1 ¾	5	400	385
	3 ½	3 1/4	400	-

For SI: 1 inch = 25.4 mm, 1 ksi = 6.89 MPa, 1 lbf = 4.45 N.

- The main and side members shall be wood having a minimum NDS referenced specific gravity of 0.50 for DF, 0.55 for SP, and 0.42 for SPF and HF. When the specific gravities or equivalent specific gravities of the main member and side member are different, the design values of the wood with the lowest specific gravity shall be used. Lateral table values for sawn lumber are also applicable for fasteners installed into structural composite lumber described in Section 3.2.2 of this report.
- Tabulated lateral design values (Z) shall be multiplied by all applicable adjustment factors, including the load duration factor, C_D, from the NDS as referenced in the IBC or IRC.
- Screws shall be installed straight into the side grain of the wood main member with the screw axis at a 90 degree angle to the wood fibers.
- Minimum fastener penetration shall be equal to the screw length less the thickness of the wood side plate.
- DF is Douglas Fir-Larch. SP is Southern Pine. SPF is Spruce-Pine-Fir. HF is Hem-Fir.



Originally Issued: 08/03/2010

Revised: 02/23/2018

Valid Through: 02/28/2019

TABLE 3 – REFERENCE WITHDRAWAL (W) DESIGN VALUES FOR WOOD-TO-WOOD CONNECTIONS WITH SDW22 WOOD SCREWS^{1,2,3,4,5,6,7}

MODEL	FASTENER LENGTH, L (in.)	THREAD LENGTH, TL (in.)	REFERENCE WITHDRAWAL DESIGN VALUE, W (lbf/in.)		MAX REFERENCE WITHDRAWAL DESIGN VALUE, W _{MAX} (lbf)	
			DF/SP MAIN MEMBER	HF/SPF MAIN MEMBER	DF/SP MAIN MEMBER	HF/SPF MAIN MEMBER
SDW22300	2.940	1 7/16	139	104	200	150
SDW22338	3.340	1 9/16	128	96		
SDW22438	4.375	1 7/16	139	104		
SDW22458	4.585	1 7/16	128	96		
SDW22500	5.040	1 9/16	139	104		
SDW22600	5.940	1 7/16	128	96		
SDW22638	6.315	1 7/16	139	104		
SDW22634	6.740	1 9/16	128	96		

For SI: 1 inch = 25.4 mm, 1 ksi = 6.89 MPa, 1 lbf = 4.45 N.

- The main members shall be wood having a minimum NDS referenced specific gravity of 0.50 for DF, 0.55 for SP, and 0.42 for SPF and HF. Withdrawal table values for sawn lumber are also applicable for fasteners installed into structural composite lumber described in Section 3.2.2 of this report.
- Tabulated reference withdrawal design values (W) is in pounds per inch of the thread penetration into the main member.
- Tabulated reference withdrawal design values (W_{MAX}) is in pounds where the entire thread length shall penetrate into the main member.
- Tabulated reference withdrawal design values (W) and (W_{MAX}) are shown at a C_D = 1.0. Loads may be increased for load duration per the building code up to a C_D = 1.6. Tabulated values shall be multiplied by all applicable adjustment factors from the NDS as referenced in the IBC or IRC.
- Screws shall be installed straight into the side grain of the wood main member with the screw axis at a 90 degree angle to the wood fibers.
- Values are based on the lesser of withdrawal from the main member or pull-through of a 1½-inch-thick side member.
- DF is Douglas Fir-Larch. SP is Southern Pine. SPF is Spruce-Pine-Fir. HF is Hem-Fir.

TABLE 4 – CONNECTION GEOMETRY FOR THE SDW22 WOOD SCREWS

CONDITION ¹		MINIMUM DISTANCE OR SPACING (in.)
Edge Distance	Perpendicular to grain loading	1 7/16
	Parallel to grain loading	1 7/16
End Distance	Perpendicular to grain loading	6
	Parallel to grain loading	6
Spacing	Between fasteners in a row	6
	Between non-staggered rows	4
	Between staggered rows	5/8

For **SI**: 1 inch = 25.4 mm, 1 lbf = 4.45 N.

¹ Edge distances, end distances and spacing of the screws shall be sufficient to prevent splitting of the wood, or as required by this table, or when applicable as recommended by the structural composite lumber manufacturer, whichever is the more restrictive.

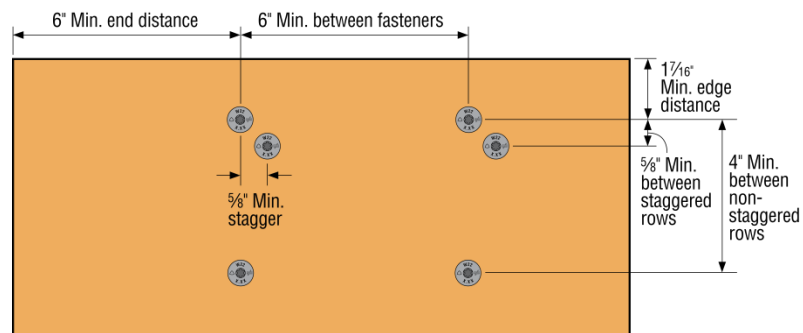

FIGURE 8 – CONNECTION GEOMETRY – SDW22 WOOD SCREWS



TABLE 5 – REFERENCE LATERAL (Z) DESIGN VALUES FOR WOOD-TO-WOOD CONNECTIONS WITH SDWS22DB WOOD SCREWS FOR DF AND SP WOOD^{1,2,3,4,5}

MODEL	THREAD LENGTH, TL (in.)	DF/SP ALLOWABLE SHEAR LOADS (lbf)								
		WOOD SIDE MEMBER THICKNESS (in.)								
		1.5	2.0	2.5	3.0	3.5	4.0	4.5	6.0	8.0
SDWS22300DB	1.5	255	-	-	-	-	-	-	-	-
SDWS22312DBB	2.0	255 ⁶	285	-	-	-	-	-	-	-
SDWS22400DB	2.375	405	405	305	-	-	-	-	-	-
SDWS22500DB	2.75	405	405	360	360	325	-	-	-	-
SDWS22512DBB	2.75	405	405	360	360	325 ⁶	300	-	-	-
SDWS22600DB	2.75	405	405	405	405	365	365	355	-	-
SDWS22800DB	2.75	405	405	405	405	395	395	395	395	-
SDWS221000DB	2.75	405	405	405	405	395	395	395	395	395

For **SI**: 1 inch = 25.4 mm, 1 ksi = 6.89 MPa, 1 lbf = 4.45 N.

- The main and side members shall be wood having a minimum NDS referenced specific gravity of 0.50 for DF and 0.55 for SP. Lateral table values for sawn lumber are also applicable for fasteners installed into structural composite lumber described in Section 3.2.2. When the specific gravities or equivalent specific gravities of the main member and side member are different, the design values of the wood with the lowest specific gravity shall be used.
- Tabulated lateral design values (Z) are shown at a $C_D = 1.0$. Loads may be increased for load duration per the building code up to a $C_D = 1.6$. Tabulated values shall be multiplied by all applicable adjustment factors from the NDS as referenced in the IBC or IRC.
- Screws shall be installed straight into the side grain of the wood main member with the screw axis at a 90 degree angle to the wood fibers.
- Minimum fastener penetration shall be equal to the screw length less the thickness of the wood side plate.
- DF is Douglas Fir-Larch. SP is Southern Pine.
- For Western Cedars 1 $\frac{1}{2}$ -inch-thick side members, an allowable design value of 225 lbf is assigned for SDWS22312DBB; for Western Cedars 2-inch-thick side members, an allowable design value of 205 lbf is assigned for SDWS22312DBB; for Western Cedars 3 $\frac{1}{2}$ -inch-thick side members, an allowable design value of 230 lbf is assigned for SDWS22512DBB.



TABLE 6 – REFERENCE LATERAL (Z) DESIGN VALUES FOR WOOD-TO-WOOD CONNECTIONS WITH SDWS22DB WOOD SCREWS FOR HF AND SPF WOOD^{1,2,3,4,5}

MODEL	THREAD LENGTH, TL (in.)	SPF/HF ALLOWABLE SHEAR LOADS (lbf)								
		WOOD SIDE MEMBER THICKNESS (in.)								
		1.5	2.0	2.5	3.0	3.5	4.0	4.5	6.0	8.0
SDWS22300DB	1.5	190	-	-	-	-	-	-	-	-
SDWS22312DBB	2.0	190	200	-	-	-	-	-	-	-
SDWS22400DB	2.375	385	285	215	-	-	-	-	-	-
SDWS22500DB	2.75	405	290	290	290	195	-	-	-	-
SDWS22512DBB	2.75	405	290	290	290	195	195	-	-	-
SDWS22600DB	2.75	405	365	365	365	310	310	210	-	-
SDWS22800DB	2.75	405	365	365	365	310	310	280	280	-
SDWS221000DB	2.75	405	365	365	365	310	310	280	280	280

For SI: 1 inch = 25.4 mm, 1 ksi = 6.89 MPa, 1 lbf = 4.45 N.

- The main and side members shall be wood having a minimum NDS referenced specific gravity of 0.42 for SPF and HF. Lateral table values for sawn lumber are also applicable for fasteners installed into structural composite lumber described in Section 3.2.2 of this report. When the specific gravities or equivalent specific gravities of the main member and side member are different, the design values of the wood with the lowest specific gravity shall be used.
- Tabulated lateral design values (Z) are shown at a $C_D = 1.0$. Loads may be increased for load duration per the building code up to a $C_D = 1.6$. Tabulated values shall be multiplied by all applicable adjustment factors from the NDS as referenced in the IBC or IRC.
- Screws shall be installed straight into the side grain of the wood main member with the screw axis at a 90 degree angle to the wood fibers.
- Minimum fastener penetration shall be equal to the screw length less the thickness of the wood side plate.
- SPF is Spruce-Pine-Fir. HF is Hem-Fir.

TABLE 6A – REFERENCE LATERAL (Z) DESIGN VALUES FOR WOOD-TO-WOOD/STEEL CONNECTIONS WITH SDWS22DB WOOD SCREWS AND STN221,2,3,4,5

MODEL	THREAD LENGTH, TL(in)	ALLOWABLE SHEAR LOADS (lbf)							
		2x WOOD SIDE MEMBER				12-GA STEEL SIDE MEMBER			
		Western Cedars	SPF/HF	DF	SP	Western Cedars	SPF/HF	DF	SP
SDWS22312DBB	2.0	179	192	235	280	320	385	470	560
SDWS22512DBB	2.75	395	430	465	545	425	495	640	640

For SI: 1 inch = 25.4 mm, 1 ksi = 6.89 MPa, 1 lbf = 4.45 N.

- The main and side members shall be wood having a minimum NDS referenced specific gravity of 0.36 for Western Cedars, 0.42 for HF and SPF, 0.50 for DF, 0.55 for SP. Lateral table values for sawn lumber are also applicable for fasteners installed into structural composite lumber described in Section 3.2.2 of this report. When the specific gravities of equivalent specific gravities of the main member and side member are different, the design values of the member with the lowest specific gravity shall be used.
- Tabulated lateral design values (Z) are shown at a $C_D = 1.0$. Loads may be increased for load duration per the building code up to a $C_D=1.6$. Tabulated values shall be multiplied by all applicable adjustment factors from the NDS as referenced in the IBC or IRC.
- Screws shall be installed straight into the side grain of the wood main member with the screw axis at a 90 degree angle to the wood fibers.
- Minimum fastener penetration shall be equal to the screw length less the thickness of the wood/steel side plate.
- SPF is Spruce-Pine-Fir. HF is Hem-Fir. DF is Douglas Fir-Larch. SP is Southern Pine.



Originally Issued: 08/03/2010

Revised: 02/23/2018

Valid Through: 02/28/2019

TABLE 7 – REFERENCE WITHDRAWAL (W) DESIGN VALUES FOR WOOD-TO-WOOD CONNECTIONS WITH SDWS22DB WOOD SCREWS^{1,2,3,4,5,6,7}

MODEL	FASTENER LENGTH, L (in.)	THREAD LENGTH, TL (in.)	REFERENCE WITHDRAWAL DESIGN VALUE, W (lbf/in.)		MAX REFERENCE WITHDRAWAL DESIGN VALUE, W _{MAX} (lbf)	
			DF AND SP MAIN MEMBER	HF AND SPF MAIN MEMBER	DF AND SP MAIN MEMBER	HF AND SPF MAIN MEMBER
SDWS22300DB	3	1 1/2	164	151	245	225
SDWS22312DBB ⁸	3.5	2	164	151	330	300
SDWS22400DB	4	2 3/8	179	160	425	380
SDWS22500DB	5	2 3/4	214	187	590	495
SDWS22512DBB ⁸	5.5	2 3/4	214	187	590	495
SDWS22600DB	6	2 3/4	214	187	590	495
SDWS22800DB	8	2 3/4	214	187	590	495
SDWS221000DB	10	2 3/4	214	187	590	495

For **SI**: 1 inch = 25.4 mm, 1 ksi = 6.89 MPa, 1 lbf = 4.45 N.

1. The main members shall be wood having a minimum NDS referenced specific gravity of 0.50 for DF, 0.55 for SP, and 0.42 for SPF and HF. Withdrawal table values for sawn lumber are also applicable for fasteners installed into structural composite lumber described in Section 3.2.2 of this report.
2. Tabulated reference withdrawal design values (W) is in pounds per inch of the thread penetration into the main member.
3. Tabulated reference withdrawal design values (W_{MAX}) is in pounds where the entire thread length shall penetrate into the main member.
4. Tabulated reference withdrawal design values (W) and (W_{MAX}) are shown at a C_D = 1.0. Loads may be increased for load duration per the building code up to a C_D = 1.6. Tabulated values shall be multiplied by all applicable adjustment factors from the NDS as referenced in the IBC or IRC.
5. Screws shall be installed straight into the side grain of the wood main member with the screw axis at a 90 degree angle to the wood fibers.
6. DF is Douglas Fir-Larch. SP is Southern Pine. SPF is Spruce-Pine-Fir. HF is Hem-Fir.
7. Values are based on the lesser of withdrawal from the main member or pull-through of a 1½-inch-thick side member.
8. For Western Cedar species, reference withdrawal design value is (W) of 142 lbf/inch of thread penetration.

TABLE 8 – CONNECTION GEOMETRY FOR THE SDWS22DB WOOD SCREWS

CONDITION ¹		MINIMUM DISTANCE OR SPACING (in.)
Edge Distance	Perpendicular to grain loading	1 7/16
	Parallel to grain loading	1 7/16
End Distance	Perpendicular to grain loading	6
	Parallel to grain loading	6
Spacing	Between fasteners in a row	8
	Between non-staggered rows	4
	Between staggered rows	5/8

For **SI**: 1 inch = 25.4 mm, 1 lbf = 4.45 N.

¹ Edge distances, end distances and spacing of the screws shall be sufficient to prevent splitting of the wood, or as required by this table, or when applicable as recommended by the structural composite lumber manufacturer, whichever is the more restrictive.

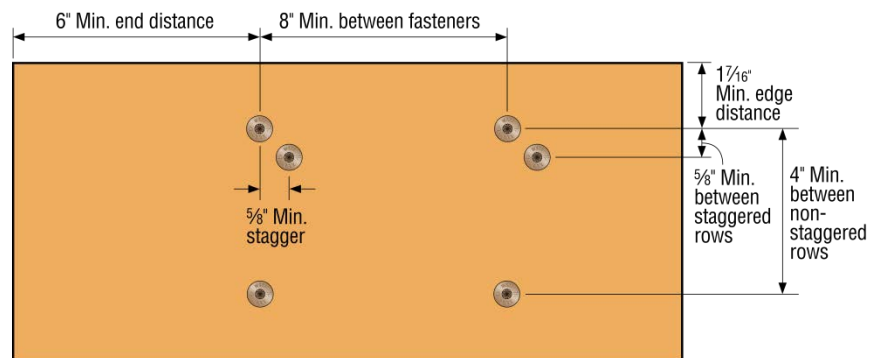

FIGURE 9 – CONNECTION GEOMETRY – SDWS22DB WOOD SCREWS



TABLE 9 – REFERENCE LATERAL (Z) DESIGN VALUES FOR WOOD-TO-WOOD CONNECTIONS WITH SDWH19DB WOOD SCREWS FOR DF AND SP WOOD^{1,2,3,4,5}

MODEL	THREAD LENGTH, TL (in.)	DF/SP ALLOWABLE SHEAR LOADS (lbf)								
		WOOD SIDE MEMBER THICKNESS (in.)								
		1.5	2.0	2.5	3.0	3.5	4.0	4.5	6.0	8.0
SDWH19300DB	1.5	285	-	-	-	-	-	-	-	-
SDWH19400DB	2.375	370	300	300	-	-	-	-	-	-
SDWH19600DB	2.75	370	265	265	265	265	245	245	-	-
SDWH19800DB	2.75	370	265	265	265	265	265	260	245	-
SDWH191000DB	2.75	370	265	265	265	265	265	260	260	245

For **SI**: 1 inch = 25.4 mm, 1 ksi = 6.89 MPa, 1 lbf = 4.45 N.

- The main and side members shall be wood having a minimum NDS referenced specific gravity of 0.50 for DF and 0.55 for SP. Lateral table values for sawn lumber are also applicable for fasteners installed into structural composite lumber described in Section 3.2.2 of this report. When the specific gravities or equivalent specific gravities of the main member and side member are different, the design values of the wood with the lowest specific gravity shall be used.
- Tabulated lateral design values (Z) are shown at a $C_D = 1.0$. Loads may be increased for load duration per the building code up to a $C_D = 1.6$. Tabulated values shall be multiplied by all applicable adjustment factors from the NDS as referenced in the IBC or IRC.
- Screws shall be installed straight into the side grain of the wood main member with the screw axis at a 90 degree angle to the wood fibers.
- Minimum fastener penetration shall be equal to the screw length less the thickness of the wood side plate.
- DF is Douglas Fir-Larch. SP is Southern Pine.

TABLE 10 – REFERENCE LATERAL (Z) DESIGN VALUES FOR WOOD-TO-WOOD CONNECTIONS WITH SDWH19DB WOOD SCREWS FOR HF AND SPF WOOD^{1,2,3,4,5}

MODEL	THREAD LENGTH, TL (in.)	SPF/HF ALLOWABLE SHEAR LOADS (lbf)								
		WOOD SIDE MEMBER THICKNESS (in.)								
		1.5	2.0	2.5	3.0	3.5	4.0	4.5	6.0	8.0
SDWH19300DB	1.5	230	-	-	-	-	-	-	-	-
SDWH19400DB	2.375	330	235	195	-	-	-	-	-	-
SDWH19600DB	2.75	350	265	265	265	265	215	180	-	-
SDWH19800DB	2.75	350	265	265	265	265	265	215	215	-
SDWH191000DB	2.75	350	265	265	265	265	265	250	250	215

For **SI**: 1 inch = 25.4 mm, 1 ksi = 6.89 MPa, 1 lbf = 4.45 N.

- The main and side members shall be wood having a minimum NDS referenced specific gravity of 0.42 for SPF and HF. Lateral table values for sawn lumber are also applicable for fasteners installed into structural composite lumber described in Section 3.2.2 of this report. When the specific gravities or equivalent specific gravities of the main member and side member are different, the design values of the wood with the lowest specific gravity shall be used.
- Tabulated lateral design values (Z) are shown at a $C_D = 1.0$. Loads may be increased for load duration per the building code up to a $C_D = 1.6$. Tabulated values shall be multiplied by all applicable adjustment factors from the NDS as referenced in the IBC or IRC.
- Screws shall be installed straight into the side grain of the wood main member with the screw axis at a 90 degree angle to the wood fibers.
- Minimum fastener penetration shall be equal to the screw length less the thickness of the wood side plate.
- SPF is Spruce-Pine-Fir. HF is Hem-Fir.



Originally Issued: 08/03/2010

Revised: 02/23/2018

Valid Through: 02/28/2019

TABLE 11 – REFERENCE WITHDRAWAL (W) DESIGN VALUES FOR WOOD-TO-WOOD CONNECTIONS WITH SDWH19DB WOOD SCREWS^{1,2,3,4,5,6,7}

MODEL	FASTENER LENGTH, L (in.)	THREAD LENGTH, TL (in.)	REFERENCE WITHDRAWAL DESIGN VALUE, W (lbf/in.)		MAX REFERENCE WITHDRAWAL DESIGN VALUE, W _{MAX} (lbf)	
			DF AND SP MAIN MEMBER	HF AND SPF MAIN MEMBER	DF AND SP MAIN MEMBER	HF AND SPF MAIN MEMBER
SDWH19300DB	3	1 1/2	177	120	265	180
SDWH19400DB	4	2 3/8	192	147	455	350
SDWH19600DB	6	2 3/4	197	164	545	445
SDWH19800DB	8	2 3/4	197	164	545	445
SDWH191000DB	10	2 3/4	197	164	545	445

For SI: 1 inch = 25.4 mm, 1 ksi = 6.89 MPa, 1 lbf = 4.45 N.

- The main members shall be wood having a minimum NDS referenced specific gravity of 0.50 for DF, 0.55 for SP, and 0.42 for SPF and HF. Withdrawal table values for sawn lumber are also applicable for fasteners installed into structural composite lumber described in Section 3.2.2 of this report.
- Tabulated reference withdrawal design values (W) is in pounds per inch of the thread penetration into the main member.
- Tabulated reference withdrawal design values (W_{MAX}) is in pounds where the entire thread length shall penetrate into the main member.
- Tabulated reference withdrawal design values (W and W_{MAX}) are shown at a C_D = 1.0. Loads may be increased for load duration per the building code up to a C_D = 1.6. Tabulated values shall be multiplied by all applicable adjustment factors from the NDS as referenced in the IBC or IRC.
- Screws shall be installed straight into the side grain of the wood main member with the screw axis at a 90 degree angle to the wood fibers.
- DF is Douglas Fir-Larch. SP is Southern Pine. SPF is Spruce-Pine-Fir. HF is Hem-Fir.
- Values are based on the lesser of withdrawal from the main member or pull-through of a 1½-inch-thick side member.

TABLE 12 – CONNECTION GEOMETRY FOR THE SDWH19DB WOOD SCREWS

CONDITION ¹		MINIMUM DISTANCE OR SPACING (in.)
Edge Distance	Perpendicular to grain loading	1 7/16
	Parallel to grain loading	1 7/16
End Distance	Perpendicular to grain loading	6
	Parallel to grain loading	6
Spacing	Between fasteners in a row	8
	Between non-staggered rows	4
	Between staggered rows	5/8

For SI: 1 inch = 25.4 mm, 1 lbf = 4.45 N.

- Edge distances, end distances and spacing of the screws shall be sufficient to prevent splitting of the wood, or as required by this table, or when applicable as recommended by the structural composite lumber manufacturer, whichever is the more restrictive.

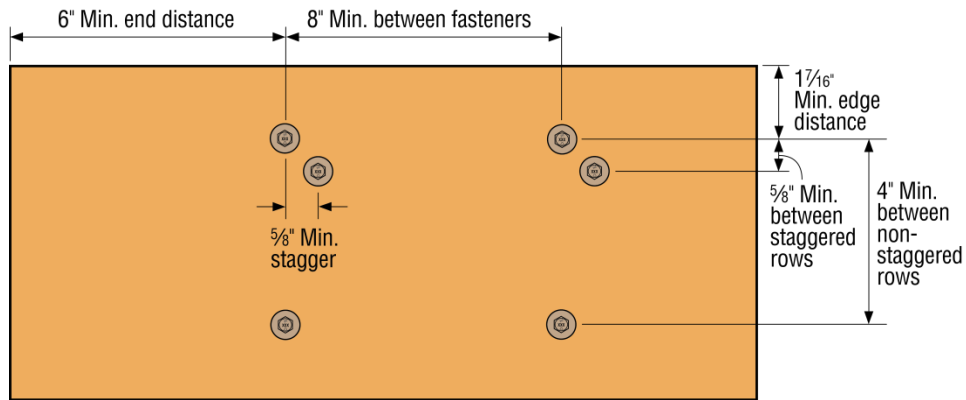

FIGURE 10 – CONNECTION GEOMETRY – SDWH19DB WOOD SCREWS

TABLE 13 – REFERENCE LATERAL (Z) DESIGN VALUES FOR WOOD-TO-WOOD CONNECTIONS WITH SDWS22 WOOD SCREWS FOR DF AND SP WOOD^{1,2,3,4,5}

MODEL	THREAD LENGTH, TL (in.)	DF/SP ALLOWABLE SHEAR LOADS (lbf)														
		WOOD SIDE MEMBER THICKNESS (in.)														
		1.5	2.0	2.5	3.0	3.5	4.0	4.5	5.0	5.5	6.0	7.0	8.0	9.0	10.0	13.0
SDWS22800	2 3/4	405	405	405	405	395	395	395	395	395	395	-	-	-	-	-
SDWS22900	2 3/4	405	405	405	405	395	395	395	395	395	395	395	-	-	-	-
SDWS221000	2 3/4	405	405	405	405	395	395	395	395	395	395	395	395	-	-	-
SDWS221100	2 3/4	405	405	405	405	395	395	395	395	395	395	395	395	395	-	-
SDWS221200	2 3/4	405	405	405	405	395	395	395	395	395	395	395	395	395	395	-
SDWS221500	2 3/4	405	405	405	405	395	395	395	395	395	395	395	395	395	395	395

For **SI**: 1 inch = 25.4 mm, 1 ksi = 6.89 MPa, 1 lbf = 4.45 N.

- The main and side members shall be wood having a minimum NDS referenced specific gravity of 0.50 for DF and 0.55 for SP. Lateral table values for sawn lumber are also applicable for fasteners installed into structural composite lumber described in Section 3.2.2 of this report. When the specific gravities or equivalent specific gravities of the main member and side member are different, the design values of the wood with the lowest specific gravity shall be used.
- Tabulated lateral design values (Z) are shown at a $C_D = 1.0$. Loads may be increased for load duration per the building code up to a $C_D = 1.6$. Tabulated values shall be multiplied by all applicable adjustment factors from the NDS as referenced in the IBC or IRC.
- Screws shall be installed straight into the side grain of the wood main member with the screw axis at a 90 degree angle to the wood fibers.
- Minimum fastener penetration shall be equal to the screw length less the thickness of the wood side plate.
- DF is Douglas Fir-Larch. SP is Southern Pine.



TABLE 14 – REFERENCE LATERAL (Z) DESIGN VALUES FOR WOOD-TO-WOOD CONNECTIONS WITH SDWS22 WOOD SCREWS FOR HF AND SPF WOOD^{1,2,3,4,5}

MODEL	THREAD LENGTH, TL (in.)	SPF/HF ALLOWABLE SHEAR LOADS (lbf)														
		WOOD SIDE MEMBER THICKNESS (in.)														
		1.5	2.0	2.5	3.0	3.5	4.0	4.5	5.0	5.5	6.0	7.0	8.0	9.0	10.0	13.0
SDWS22800	2 3/4	400	365	365	365	310	310	280	280	280	280	-	-	-	-	-
SDWS22900	2 3/4	400	365	365	365	310	310	280	280	280	280	280	-	-	-	-
SDWS221000	2 3/4	400	365	365	365	310	310	280	280	280	280	280	280	-	-	-
SDWS221100	2 3/4	400	365	365	365	310	310	280	280	280	280	280	280	280	-	-
SDWS221200	2 3/4	400	365	365	365	310	310	280	280	280	280	280	280	280	280	-
SDWS221500	2 3/4	400	365	365	365	310	310	280	280	280	280	280	280	280	280	280

For **SI**: 1 inch = 25.4 mm, 1 ksi = 6.89 MPa, 1 lbf = 4.45 N.

- The main and side members shall be wood having a minimum NDS referenced specific gravity of 0.42 for SPF and HF. Lateral table values for sawn lumber are also applicable for fasteners installed into structural composite lumber described in Section 3.2.2 of this report. When the specific gravities or equivalent specific gravities of the main member and side member are different, the design values of the wood with the lowest specific gravity shall be used.
- Tabulated lateral design values (Z) are shown at a $C_D = 1.0$. Loads may be increased for load duration per the building code up to a $C_D = 1.6$. Tabulated values shall be multiplied by all applicable adjustment factors from the NDS as referenced in the IBC or IRC.
- Screws shall be installed straight into the side grain of the wood main member with the screw axis at a 90 degree angle to the wood fibers.
- Minimum fastener penetration shall be equal to the screw length less the thickness of the wood side plate.
- SPF is Spruce-Pine-Fir. HF is Hem-Fir.



Originally Issued: 08/03/2010

Revised: 02/23/2018

Valid Through: 02/28/2019

TABLE 15 – REFERENCE WITHDRAWAL (W) DESIGN VALUES FOR WOOD-TO-WOOD CONNECTIONS WITH SDWS22 WOOD SCREWS^{1,2,3,4,5,6,7}

MODEL	FASTENER LENGTH, L (in.)	THREAD LENGTH, TL (in.)	REFERENCE WITHDRAWAL DESIGN VALUE, W (lbf/in.)		MAX REFERENCE WITHDRAWAL DESIGN VALUE, W _{MAX} (lbf)	
			DF AND SP MAIN MEMBER	HF AND SPF MAIN MEMBER	DF AND SP MAIN MEMBER	HF AND SPF MAIN MEMBER
SDWS22800	8	2 3/4	214	187	590	495
SDWS22900	9	2 3/4	214	187	590	495
SDWS221000	10	2 3/4	214	187	590	495
SDWS221100	11	2 3/4	214	187	590	495
SDWS221200	12	2 3/4	214	187	590	495
SDWS221500	15	2 3/4	214	187	590	495

For **SI**: 1 inch = 25.4 mm, 1 ksi = 6.89 MPa, 1 lbf = 4.45 N.

- The main members shall be wood having a minimum NDS referenced specific gravity of 0.50 for DF, 0.55 for SP, and 0.42 for SPF and HF. Withdrawal values for sawn lumber are also applicable for fasteners installed into structural composite lumber described in Section 3.2.2 of this report.
- Tabulated reference withdrawal design values (W) is in pounds per inch of the thread penetration into the main member.
- Tabulated reference withdrawal design values (W_{MAX}) is in pounds where the entire thread length shall penetrate into the main member.
- Tabulated reference withdrawal design values (W and W_{MAX}) are shown at a C_D = 1.0. Loads may be increased for load duration per the building code up to a C_D = 1.6. Tabulated values shall be multiplied by all applicable adjustment factors from the NDS as referenced in the IBC or IRC.
- Screws shall be installed straight into the side grain of the wood main member with the screw axis at a 90 degree angle to the wood fibers.
- DF is Douglas Fir-Larch. SP is Southern Pine. SPF is Spruce-Pine-Fir. HF is Hem-Fir.
- Values are based on the lesser of withdrawal from the main member or pull-through of a 1½-inch-thick side member.

TABLE 16 – CONNECTION GEOMETRY FOR THE SDWS22 WOOD SCREWS

	CONDITION ¹	MINIMUM DISTANCE OR SPACING (in.)
Edge Distance	Perpendicular to grain loading	1 7/16
	Parallel to grain loading	1 7/16
End Distance	Perpendicular to grain loading	6
	Parallel to grain loading	6
Spacing	Between fasteners in a row	8
	Between non-staggered rows	4
	Between staggered rows	5/8

For **SI**: 1 inch = 25.4 mm, 1 lbf = 4.45 N.

- Edge distances, end distances and spacing of the screws shall be sufficient to prevent splitting of the wood, or as required by this table, or when applicable as recommended by the structural composite lumber manufacturer, whichever is the more restrictive.

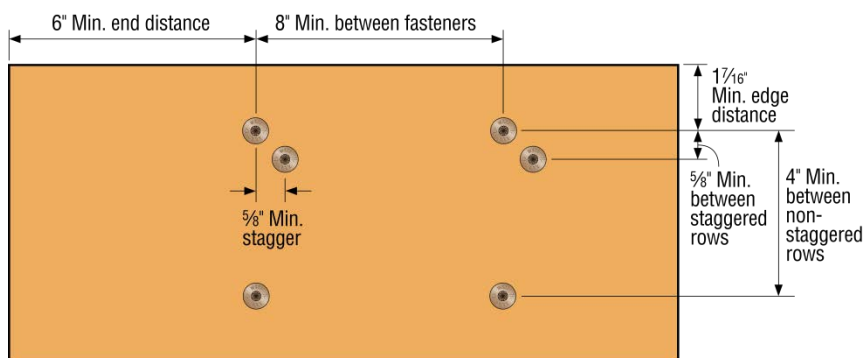

FIGURE 11 – CONNECTION GEOMETRY – SDWS22 WOOD SCREWS

TABLE 17 – REFERENCE LATERAL (Z) DESIGN VALUES FOR WOOD-TO-WOOD CONNECTIONS WITH SDWS19 WOOD SCREWS FOR DF AND SP WOOD^{1,2,3,4,5}

MODEL	THREAD LENGTH, TL (in.)	DF/SP ALLOWABLE SHEAR LOADS (lbf)									
		WOOD SIDE MEMBER THICKNESS (in.)									
		1.5	2.0	2.5	3.0	3.5	4.0	4.5	5.0	5.5	6.0
SDWS19600	2 3/4	370	265	265	265	265	245	245	-	-	-
SDWS19712	2 3/4	370	265	265	265	265	245	245	245	245	245

For **S**: 1 inch = 25.4 mm, 1 ksi = 6.89 MPa, 1 lbf = 4.45 N.

- ¹. The main and side members shall be wood having a minimum NDS referenced specific gravity of 0.50 for DF and 0.55 for SP. Lateral table values for sawn lumber are also applicable for fasteners installed into structural composite lumber described in Section 3.2.2 of this report. When the specific gravities or equivalent specific gravities of the main member and side member are different, the design values of the wood with the lowest specific gravity shall be used.
- ². Tabulated lateral design values (Z) are shown at a $C_D = 1.0$. Loads may be increased for load duration per the building code up to a $C_D = 1.6$. Tabulated values shall be multiplied by all applicable adjustment factors from the NDS as referenced in the IBC or IRC.
- ³. Screws shall be installed straight into the side grain of the wood main member with the screw axis at a 90 degree angle to the wood fibers.
- ⁴. Minimum fastener penetration shall be equal to the screw length less the thickness of the wood side plate.
- ⁵. DF is Douglas Fir-Larch. SP is Southern Pine.



TABLE 18 – REFERENCE LATERAL (Z) DESIGN VALUES FOR WOOD-TO-WOOD CONNECTIONS WITH SDWS19 WOOD SCREWS FOR HF AND SPF WOOD^{1,2,3,4,5}

MODEL	THREAD LENGTH, TL (in.)	SPF/HF ALLOWABLE SHEAR LOADS (lbf)									
		WOOD SIDE MEMBER THICKNESS (in.)									
		1.5	2.0	2.5	3.0	3.5	4.0	4.5	5.0	5.5	6.0
SDWS19600	2 3/4	350	265	265	265	265	215	180	-	-	-
SDWS19712	2 3/4	350	265	265	265	265	215	215	215	215	180

For SI: 1 inch = 25.4 mm, 1 ksi = 6.89 MPa, 1 lbf = 4.45 N.

- The main and side members shall be wood having a minimum NDS referenced specific gravity of 0.42 for SPF and HF. Lateral table values for sawn lumber are also applicable for fasteners installed into structural composite lumber described in Section 3.2.2 of this report. When the specific gravities or equivalent specific gravities of the main member and side member are different, the design values of the wood with the lowest specific gravity shall be used.
- Tabulated lateral design values (Z) are shown at a $C_D = 1.0$. Loads may be increased for load duration per the building code up to a $C_D = 1.6$. Tabulated values shall be multiplied by all applicable adjustment factors from the NDS as referenced in the IBC or IRC.
- Screws shall be installed straight into the side grain of the wood main member with the screw axis at a 90 degree angle to the wood fibers.
- Minimum fastener penetration shall be equal to the screw length less the thickness of the wood side plate.
- SPF is Spruce-Pine-Fir. HF is Hem-Fir.

TABLE 19 – REFERENCE WITHDRAWAL (W) DESIGN VALUES FOR WOOD-TO-WOOD CONNECTIONS WITH SDWS19 WOOD SCREWS^{1,2,3,4,5,6,7}

MODEL	FASTENER LENGTH, L (in.)	THREAD LENGTH, TL (in.)	REFERENCE WITHDRAWAL DESIGN VALUE, W (lbf/in.)		MAX REFERENCE WITHDRAWAL DESIGN VALUE, W _{MAX} (lbf)	
			DF AND SP MAIN MEMBER	HF AND SPF MAIN MEMBER	DF AND SP MAIN MEMBER	HF AND SPF MAIN MEMBER
			SDWS19600	6	2 3/4	197
SDWS19712	7.5	2 3/4	197	164	545	395

For SI: 1 inch = 25.4 mm, 1 ksi = 6.89 MPa, 1 lbf = 4.45 N.

- The main members shall be wood having a minimum NDS referenced specific gravity of 0.50 for DF, 0.55 for SP, and 0.42 for SPF and HF. Withdrawal table values for sawn lumber are applicable for fasteners installed into structural composite lumber described in Section 3.2.2.
- Tabulated reference withdrawal design values (W) is in pounds per inch of the thread penetration into the main member.
- Tabulated reference withdrawal design values (W_{MAX}) is in pounds where the entire thread length shall penetrate into the main member.
- Tabulated reference withdrawal design values (W and W_{MAX}) are shown at a $C_D = 1.0$. Loads may be increased for load duration per the building code up to a $C_D = 1.6$. Tabulated values shall be multiplied by all applicable adjustment factors from the NDS as referenced in the IBC or IRC.
- Screws shall be installed straight into the side grain of the wood main member with the screw axis at a 90 degree angle to the wood fibers.
- DF is Douglas Fir-Larch. SP is Southern Pine. SPF is Spruce-Pine-Fir. HF is Hem-Fir.
- Values are based on the lesser of withdrawal from the main member or pull-through of a 1½-inch-thick side member.

TABLE 20 – CONNECTION GEOMETRY FOR THE SDWH19DB WOOD SCREWS¹

CONDITION ¹		MINIMUM DISTANCE OR SPACING (in.)
Edge Distance	Perpendicular to grain loading	1 7/16
	Parallel to grain loading	1 7/16
End Distance	Perpendicular to grain loading	6
	Parallel to grain loading	6
Spacing	Between fasteners in a row	8
	Between non-staggered rows	4
	Between staggered rows	5/8

For **SI**: 1 inch = 25.4 mm, 1 lbf = 4.45 N.

¹. Edge distances, end distances and spacing of the screws shall be sufficient to prevent splitting of the wood, or as required by this table, or when applicable as recommended by the structural composite lumber manufacturer, whichever is the more restrictive.

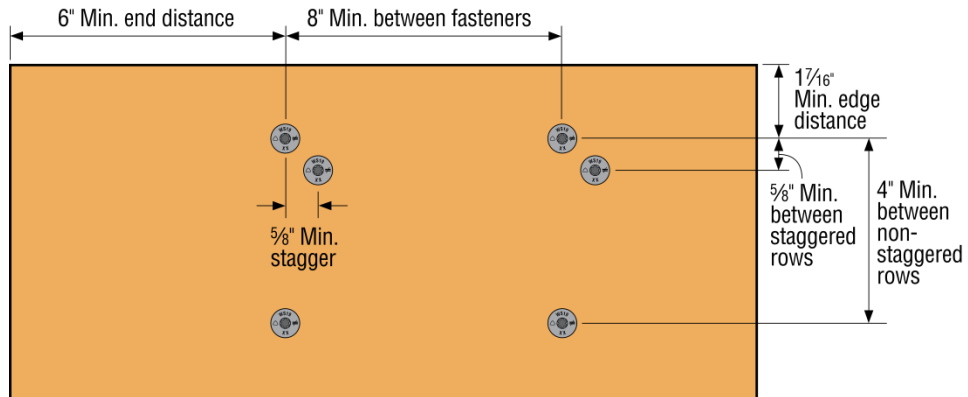

FIGURE 12 – CONNECTION GEOMETRY – SDWS19 WOOD SCREWS



Originally Issued: 08/03/2010

Revised: 02/23/2018

Valid Through: 02/28/2019

TABLE 21 – REFERENCE LATERAL (Z) DESIGN VALUES FOR WOOD-TO-WOOD CONNECTIONS WITH SDWH27G WOOD SCREWS FOR SP, DF AND HF/SPF WOOD^{1,2,3,4,5,6}

MODEL	FASTENER LENGTH, L (in.)	THREAD LENGTH, TL (in.)	ALLOWABLE SHEAR LOADS (lbf)					
			WOOD SIDE MEMBER THICKNESS (in.)					
			SP		DF		HF/SPF	
			1.5	3.0	1.5	3.0	1.5	3.0
SDWH27400G	4	3	505	-	440	-	400	-
SDWH27600G	6	3	505	545	440	545	400	450
SDWH27800G	8	3	570	675	440	675	430	595
SDWH271000G	10	3	570	675	440	675	430	595
SDWH271200G	12	3	570	675	440	675	430	595

For **SI**: 1 inch = 25.4 mm, 1 ksi = 6.89 MPa, 1 lbf = 4.45 N.

¹. The main and side members shall be wood having a minimum NDS referenced specific gravity of 0.50 for DF, 0.55 for SP, and 0.42 for SPF and HF. Lateral table values for sawn lumber are also applicable for fasteners installed into structural composite lumber described in Section 3.2.2 of this report. When the specific gravities or equivalent specific gravities of the main member and side member are different, the design values of the wood with the lowest specific gravity shall be used.

². Tabulated lateral design values (Z) are shown at a $C_D = 1.0$. Loads may be increased for load duration per the building code up to a $C_D = 1.6$. Tabulated values shall be multiplied by all applicable adjustment factors from the NDS as referenced in the IBC or IRC. For in-service moisture content greater than 19 percent use $C_M = 0.70$.

³. Screws shall be installed straight into the side grain of the wood main member with the screw axis at a 90 degree angle to the wood fibers.

⁴. Minimum fastener penetration shall be equal to the screw length less the thickness of the wood side plate.

⁵. DF is Douglas Fir-Larch. SP is Southern Pine. SPF is Spruce-Pine-Fir. HF is Hem-Fir.

⁶. [Table 23 of this report](#) contains potential geometry reductions.



TABLE 22 – REFERENCE WITHDRAWAL (W) DESIGN VALUES FOR WOOD-TO-WOOD CONNECTIONS WITH SDWH27G WOOD SCREWS^{1,2,3,4,5,6,7}

MODEL	FASTENER LENGTH, L (in.)	THREAD LENGTH, TL (in.)	REFERENCE WITHDRAWAL DESIGN VALUE, W (lbf/in.)			MAX REFERENCE WITHDRAWAL DESIGN VALUE, W _{MAX} (lbf)		
			SP MAIN MEMBER	DF MAIN MEMBER	HF AND SPF MAIN MEMBER	SP MAIN MEMBER	DF MAIN MEMBER	HF AND SPF MAIN MEMBER
SDWH27400G	4	3	287	255	212	860	765	635
SDWH27600G	6	3						
SDWH27800G	8	3						
SDWH271000G	10	3						
SDWH271200G	12	3						

For SI: 1 inch = 25.4 mm, 1 ksi = 6.89 MPa, 1 lbf = 4.45 N.

- The main members shall be wood having a minimum NDS referenced specific gravity of 0.50 for DF, 0.55 for SP, and 0.42 for SPF and HF. Withdrawal table values for sawn lumber are also applicable for fasteners installed into structural composite lumber described in Section 3.2.2 of this report.
- Tabulated reference withdrawal design values (W) is in pounds per inch of the thread penetration into the main member.
- Tabulated reference withdrawal design values (W_{MAX}) is in pounds where the entire thread length shall penetrate into the main member.
- Tabulated reference withdrawal design values (W and W_{MAX}) are shown at a C_D = 1.0. Loads may be increased for load duration per the building code up to a C_D = 1.6. Tabulated values shall be multiplied by all applicable adjustment factors from the NDS as referenced in the IBC or IRC. For in-service moisture content greater than 19 percent use C_M=0.65.
- Screws shall be installed straight into the side grain of the wood main member with the screw axis at a 90 degree angle to the wood fibers.
- DF is Douglas Fir-Larch. SP is Southern Pine. SPF is Spruce-Pine-Fir. HF is Hem-Fir.
- Values are based on the lesser of withdrawal from the main member or pull-through of a 1½-inch-thick side member.

TABLE 23 – CONNECTION GEOMETRY FOR THE SDWH27G WOOD SCREWS^{1,2}

CONDITION ¹		MINIMUM DISTANCE OR SPACING (in.)	Reduction Factor
Edge Distance	Perpendicular to grain loading	1 7/16	1.0
	Parallel to grain loading	1 1/2	1.0
End Distance	Perpendicular to grain loading	6	1.0
	Parallel to grain loading	8	1.0
Spacing	Between fasteners in a row	8	0.80
	Between non-staggered rows	4	0.89
	Between staggered rows	5/8	0.78

For SI: 1 inch = 25.4 mm, 1 lbf = 4.45 N.

- Edge distances, end distances and spacing of the screws shall be sufficient to prevent splitting of the wood, or as required by this table, or when applicable as recommended by the structural composite lumber manufacturer, whichever is the more restrictive.
- Allowable shear loads shall be multiplied by the tabulated reduction factors when used in the corresponding geometry.

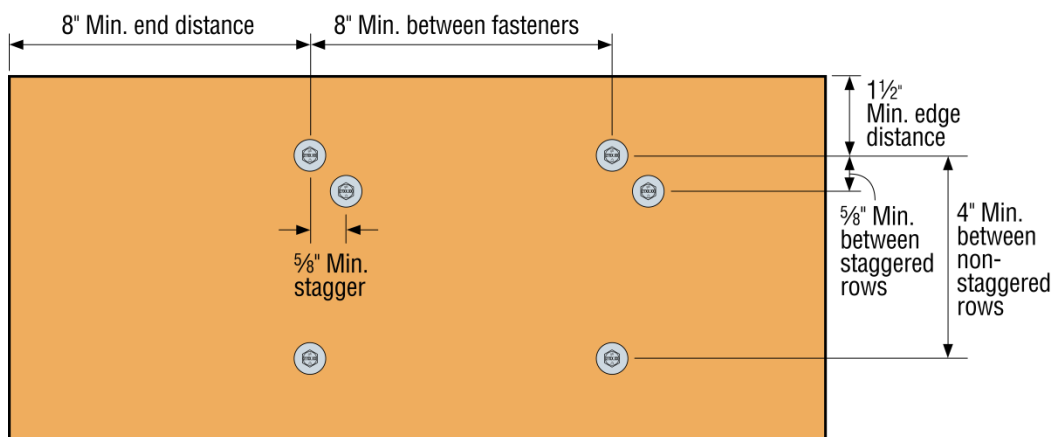

FIGURE 13 – CONNECTION GEOMETRY – SDWH27G WOOD SCREWS

TABLE 24 – REFERENCE LATERAL (Z) DESIGN VALUES FOR WOOD-TO-WOOD CONNECTIONS WITH SDWS16 WOOD SCREWS^{1,2,3,4,5}

MODEL	SIDE MEMBER THICKNESS (in.)	MAIN MEMBER PENETRATION (in.)	ALLOWABLE SHEAR LOADS (lbf)		
			SP	DFL	SPF/HF
SDWS16212	1 1/2	0.90	131	106	99
SDWS16300	1 1/2	1.40	229	150	150
	2	0.90	-	129	89

For **SI**: 1 inch = 25.4 mm, 1 ksi = 6.89 MPa, 1 lbf = 4.45 N.

- The main and side members shall be wood having a minimum NDS referenced specific gravity of 0.50 for DF, 0.55 for SP, and 0.42 for SPF and HF. When the specific gravities or equivalent specific gravities of the main member and side member are different, the design values of the wood with the lowest specific gravity shall be used. Lateral table values for sawn lumber are also applicable for fasteners installed into structural composite lumber described in Section 3.2.2 of this report.
- Tabulated lateral design values (Z) are shown at a $C_D = 1.0$. Loads may be increased for load duration per the building code up to a $C_D = 1.6$. Tabulated values shall be multiplied by all applicable adjustment factors from the NDS as referenced in the IBC or IRC. For in-service moisture content greater than 19 percent use $C_M = 0.70$.
- Screws shall be installed straight into the side grain of the wood main member with the screw axis at a 90 degree angle to the wood fibers.
- Minimum fastener penetration shall be equal to the screw length less the thickness of the wood side plate.
- DF is Douglas Fir-Larch. SP is Southern Pine. SPF is Spruce-Pine-Fir. HF is Hem-Fir.
- [Table 26](#) of this report contains geometry reductions.



TABLE 25 – REFERENCE WITHDRAWAL (W) DESIGN VALUES FOR WOOD-TO-WOOD CONNECTIONS WITH SDWS16 WOOD SCREWS^{1,2,3,4,5,6}

MODEL	FASTENER LENGTH, L (in.)	THREAD LENGTH, TL (in.)	REFERENCE WITHDRAWAL DESIGN VALUE, W (lbf/in.)			MAX REFERENCE WITHDRAWAL DESIGN VALUE, W _{MAX} (lbf)		
			SP	DFL	SPF/HF	SP	DFL	SPF/HF
SDWS16212	2.40	1.125	177	132	103	199	149	116
SDWS16300	2.90	1.625	192	127	122	310	205	200

For SI: 1 inch = 25.4 mm, 1 ksi = 6.89 MPa, 1 lbf = 4.45 N.

- The main members shall be wood having a minimum NDS referenced specific gravity of 0.50 for DF, 0.55 for SP, and 0.42 for SPF and HF. Withdrawal table values for sawn lumber are applicable for fasteners installed into structural composite lumber described in Section 3.2.2 of this report.
- Tabulated reference withdrawal design values (W) is in pounds per inch of the thread penetration into the main member.
- Tabulated reference withdrawal design values (W_{MAX}) is in pounds where the entire thread length shall penetrate into the main member.
- Tabulated reference withdrawal design values (W) and (W_{MAX}) are shown at a C_D = 1.0. Loads may be increased for load duration per the building code up to a C_D = 1.6. Tabulated values shall be multiplied by all applicable adjustment factors from the NDS as referenced in the IBC or IRC. For in-service moisture content greater than 19 percent use C_M=0.65.
- Screws shall be installed straight into the side grain of the wood main member with the screw axis at a 90 degree angle to the wood fibers.
- DF is Douglas Fir-Larch. SP is Southern Pine. SPF is Spruce-Pine-Fir. HF is Hem-Fir.
- Values are based on the lesser of withdrawal from the main member or pull-through of a 1½ inch thick side member.

TABLE 26 – CONNECTION GEOMETRY FOR THE SDWS16 WOOD SCREWS

CONDITION		MINIMUM DISTANCE OR SPACING (in.)			
		SDWS16212	Reduction Factor	SDWS16300	Reduction Factor
End Distance	Loading toward end	2	1.0	3	1.0
	Loading away from end	2	1.0	3	1.0
	Loading perpendicular to grain	3 1/2	1.0	4	1.0
Edge Distance	Loading parallel to grain	1/2	1.0	1	1.0
	Loading perpendicular to grain	1	1.0	1	1.0
Spacing between Fasteners in a Row	Loading parallel to grain	2	1.0	2	1.0
	Loading perpendicular to grain	2	1.0	2	1.0
Spacing between Rows	In-line rows	1	0.93	1	0.91
	Staggered rows	7/16	1.0	7/16	1.0

For SI: 1 inch = 25.4 mm, 1 lbf = 4.45 N.

- Edge distances, end distances and spacing of the screws shall be sufficient to prevent splitting of the wood, or as required by this table, or when applicable as recommended by the structural composite lumber manufacturer, whichever is the more restrictive.
- Allowable shear loads shall be multiplied by the tabulated reduction factors when used in the corresponding geometry.

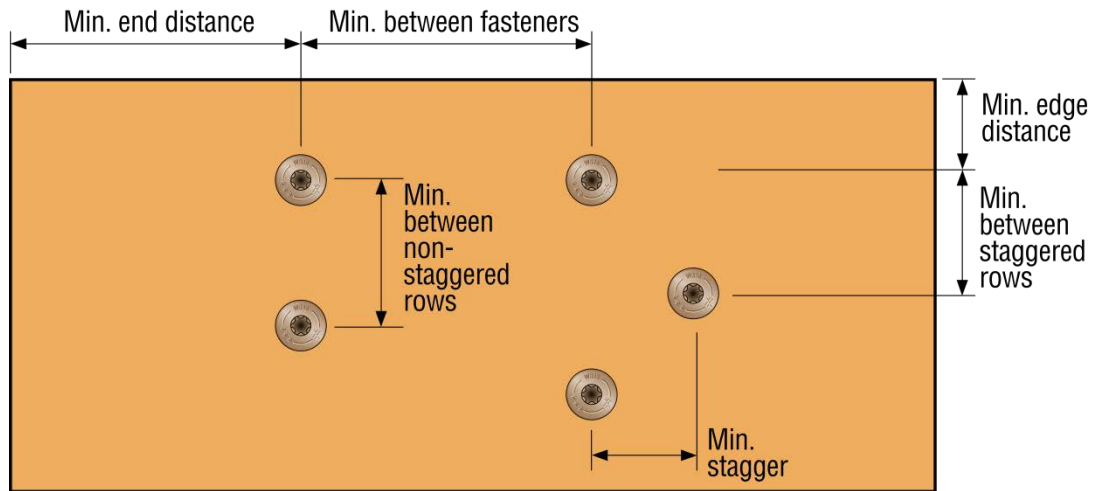

FIGURE 14 – CONNECTION GEOMETRY – SDWS16 WOOD SCREWS

TABLE 27 – RECOGNIZED EXPOSURE CONDITIONS FOR SIMPSON STRONG-TIE SDW, SDWS AND SDWH WOOD SCREWS

EXPOSURE CONDITION	TYPICAL APPLICATIONS	RECOGNITION LIMITATIONS
1	Treated wood in dry use applications	Limited to use where equilibrium moisture content of the chemically treated wood meets the dry services condition as described in NDS
3	General Construction	Limited to freshwater and chemically treated wood exposure, e.g., no salt water exposure

TABLE 28 – EDGE AND END DISTANCE AND SPACING REQUIREMENTS FOR SCREWS LOADED IN WITHDRAWAL

FASTENER	END DISTANCE (inches)	EDGE DISTANCE (inch)	SPACING (inches)
SDW22	1.250	0.500	1.250
SDWS22DB	1.250	0.500	1.250
SDWH19	1.250	0.500	1.250
SDWS22	1.250	0.500	1.250
SDWS19	1.250	0.500	1.250
SDWH27G	1.625	0.625	1.625
SDWS16	0.875	0.375	0.875

For SI: 1 inch = 25.4 mm